

MY YOUR®

ITALIAN OUTDOOR EXPERIENCE

OPEN-AIR

MY YOUR®

ITALIAN OUTDOOR EXPERIENCE

OPEN-AIR



L'esperienza tutta italiana di MYYOUR fonde insieme design, tecnologia e professionalità per creare, arredare e vivere il proprio spazio esterno in modo eccellente, qualitativo e sensoriale. Benvenuti in "Italian Outdoor Experience", il nuovo corso aziendale di MYYOUR®.

The MYYOUR's all-Italian experience combines design, technology and professionalism to create, furnish and live your outdoor space in an excellent, qualitative and multisensory way. Welcome to "Italian Outdoor Experience", MYYOUR's new corporate course.



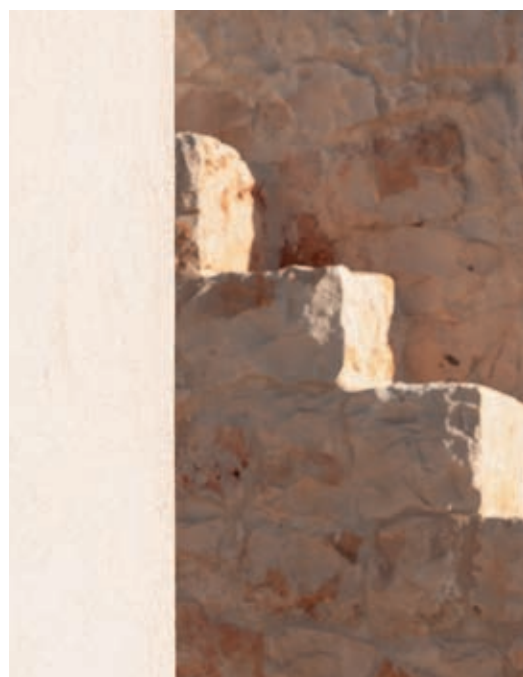

Divani e poltrone  
Sofas and armchairs

28 SAMURAI

36 2054

48 CHICO

58 NOVA

74 LILY

82 MODI'

Sedute e tavoli  
Seats and table

88 COMMUNITY SET

96 MISS PETRA

102 MR LEM

110 BART

116 PANDORA

124 OXFORD

130 LIBERTY

Banconi  
Counters

136 NOVA BANCONE

146 DUBLIN

156 BARAONDA

Coperture  
Sun covers

164 KITE

	Separatori Dividers	Vasi per esterno Outdoor pots	Complementi Accessories
172	FLAMINGO	230 GEM	258 TINO
178	NONVASO	238 PANDORA POTS	264 CRAZY HEAD
184	FRAMES	244 SKIN	
190	BA_GIGIO	256 TAO	270 Indice lampade Light Index
	Lettini Sunbeds	Docce Showers	360 Indice tecnico Tech index
196	CLOE	224 DYNO	484 Indice tecnico luci Lights tech index
204	ZOE		544 Le nostre eccellenze Our excellences
210	NOVA LETTINO		
218	BALI		570 Panoramica dei materiali Materials overview







MY YOUR è una storia, una famiglia e un'azienda di design italiana.  
 MY YOUR si è evoluta, nel corso del tempo, trasformando e migliorando il proprio design e implementando le innovazioni tecnologiche di pari passo con la propria brand identity.  
 MY YOUR presenta oggi la sua nuova e consolidata identità di editore e produttore di arredi e complementi che aiutano a creare spazi dalla forte personalità, senza mai trascurarne l'eleganza della forma e l'eccellenza qualitativa.  
 MY YOUR diventa così un'esperienza di successo, interamente sviluppata e prodotta in Italia, sia come marchio, sia come linguaggio estetico e funzionale delle proprie collezioni outdoor.

MY YOUR is a story, a family and an Italian design company.  
 MY YOUR has evolved itself, over time, transforming and improving its design and implementing technological innovations alongside its brand identity.  
 Today MY YOUR introduces its new and consolidated corporate identity as editor and producer of furniture and accessories that help to create spaces with a strong personality, without neglecting its elegance of form and quality excellence.  
 MY YOUR thus becomes a successful experience, entirely developed and produced in Italy, both as a brand and as an aesthetic and functional language of its outdoor collections.





L'evoluzione di MY YOUR porta in sé i valori di **tradizione** della grande manifattura italiana, di **innovazione tecnologica** e di costante **ricerca** di materiali e soluzioni costruttive per proporre prodotti ergonomici, eleganti in grado di comunicare relax a prima vista. La **creatività** di ogni progetto è per MY YOUR il fondamento costruttivo per sviluppare e industrializzare l'impensabile, e per offrire stili diversi in grado di soddisfare il cliente con la sua ampia scelta.

La **sostenibilità** è un valore inscindibile dal concetto di outdoor. L'attenzione e la cura dei dettagli di MY YOUR rivolta a questo tema sta spingendo sempre di più verso un utilizzo dei materiali e di processi costruttivi che implementino in futuro un sistema di economia circolare, in grado di minimizzare l'impatto ambientale della produzione industriale, totalmente realizzata in azienda. Essere sostenibile per MY YOUR significa, pertanto, reinterpretare il concetto di design come espressione della forma in un contesto mondiale in cui l'ambiente necessita la priorità.

MY YOUR's evolution brings in itself the values of the great Italian manufacture **tradition**, of the **technological innovation** and the constant **research** of materials and constructive solutions to offer ergonomic products, elegant able to communicate relaxation at first sight. The creativity of each project is for MY YOUR the constructive foundation to develop and industrialize the unthinkable, and to offer different styles able to satisfy the customer with its wide choice.

**Sustainability** is an inseparable value from the concept of outdoor. The MY YOUR attention, focused to this issue, is driving more and more towards the use of materials and construction processes that will implement a system of circular economy in the future, able to minimize the environmental impact of the industrial production, completely made in the company. Being sustainable for MY YOUR means, therefore, reinterpreting the concept of design as expression of form in a world context where the environment needs priority.







MY YOUR lavora da sempre in modo **sostenibile**, ponendo il focus sulla **trasparenza** e sulla rigida osservazione delle **leggi vigenti** in tutti i processi industriali (che avvengono interamente in azienda) e sullo smaltimento di ogni singolo scarto.

MY YOUR, attraverso la propria Ricerca e Sviluppo, crea **processi industriali** che sono in grado di soddisfare il mercato in termini di eccellenza qualitativa e di gestione dell'impatto ambientale.

Un esempio è Il **Poleasy®**, uno speciale polietilene messo a punto da MY YOUR in molti anni di ricerca, che elimina la maggior parte delle microporosità superficiali e della formazione di fessurazioni che si possono creare nel tempo sui prodotti o sui componenti in materia plastica. Questo processo permette, infatti, superfici più compatte e performance eccellenti in termini di durata, brillantezza dei colori e lavabilità.

Poleasy® è **totalmente riciclabile**.

MY YOUR has always worked in a **sustainable way**, focusing on **transparency** and strict observation of the laws in force in all industrial processes (which take place entirely in the company) and on the disposal of every single waste.

MY YOUR, through its R&D, creates **industrial processes** that are able to satisfy the market in terms of quality excellence and environmental impact management.

An example is **The Poleasy®**, a special polyethylene developed by MY YOUR in many years long research, which eliminates most of the surface microporosities and the formation of cracks that might be created over time on plastic products or components. This process allows, in fact, more compact surfaces and excellent performance in terms of durability, colour brilliance and washability.

Poleasy® is **totally recyclable**.



**LANZAVECCHIA WAY**

Joy

**PAOLO DE LUCCHI**

Nefos

**SIMONE MICHELI**

Bagigio

**PAOLO CAPPELLO**

Gem

**MASSIMO ZANIBONI**

Non Vaso

**VALERIO COMETTI**

2054

**MORE DESIGN**

Samurai  
Chico  
Modi  
Lily  
Community set  
Rhonda  
Miss Petra  
Liberty  
Teddy  
Bart  
Mr Lem  
Dyno  
Cloe  
Zoe  
Flamingo  
Baraonda  
Tulip  
Penelope  
Agata  
Agata Wood  
Baby Love

**ISABELLA LOVERO**

Skin  
Tino

**ENRICO BOSA**

Skin  
Tino

**BROGLIATO TRAVERSO**

Nova  
Pandora  
Oxford  
Dublin  
Frames  
Ampoule  
Hollywood  
Pandora Lights  
Mobi

**ALE GIORGINI**

Mobi

**ROSARIA COPETA**

Tao

**CROUSCALOGERO**

Crazy Head

**MY YOUR R&D**

Bali

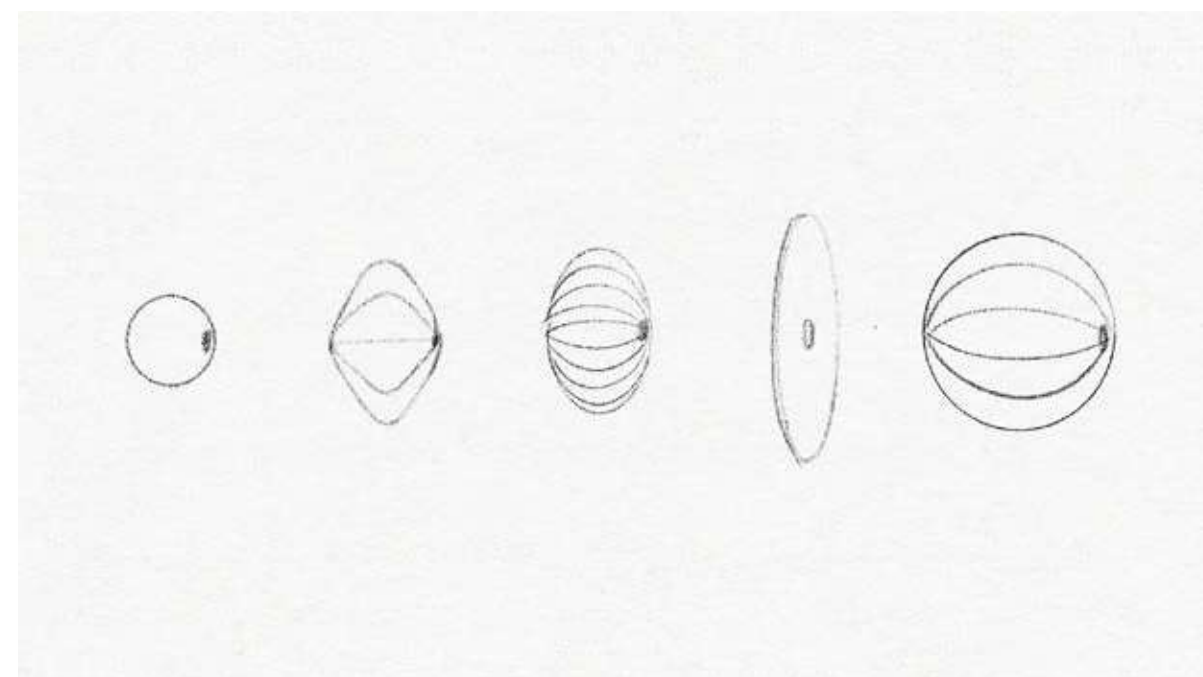

MY YOUR ha focalizzato la propria identità, sin dai suoi esordi, sul design come elemento distintivo delle proprie collezioni. La ricerca del designer è fondamentale per la crescita del brand.

Le collaborazioni sono diverse e nascono dall'idea di prodotto che MY YOUR vuole creare, perciò studi famosi, nuovi progettisti e la Ricerca e Sviluppo interna all'azienda divengono espressione stessa dello stile del marchio. In breve, MY YOUR.

Right from its beginning, MY YOUR has focused its identity on design as the distinctive element for its collections. The designer selection is fundamental for the brand growing.

The collaborations are different and start from the product idea that MY YOUR wish to create, so, well-known studios, new designers and the in-house R&D become the expression itself of the company style. In short, MY YOUR.

### Lanzavecchia+Wai

Francesca Lanzavecchia e Hunn Wai hanno creato il loro Studio di design nel 2009, con sedi a Pavia e a Singapore. I loro progetti comprendono prodotti ed edizioni limitate per aziende dal design iconico e progetti speciali per fondazioni culturali e famose maison. Fra i vari riconoscimenti, il premio EDIDA 2014 di Elle Decor come "Young Designer - Talent of the Year".

Francesca Lanzavecchia and Hunn Wai established their design studio in 2009, with offices in Pavia and Singapore. Their projects include products and limited editions for iconic design brands and special projects for fashion houses and culture foundations. Among their various awards, the 2014 Elle Decor's EDIDA one as "Young Designer Talent of the Year".



### More Design

E' una società padovana, fondata nel 2007, di industrial design, specializzata in ricerca, innovazione, engineering, industrializzazione e marketing intorno al prodotto, che garantisce il risultato finale secondo le aspettative del cliente. Lavora per aziende riconosciute sia in Italia che all'estero. More Design vince il premio A' Design Award/Gold con la collezione Push di MY YOUR nel 2022.

It is a industrial design company from Padua, founded in 2007, specialized in research, innovation, engineering, industrialization and product marketing, that guarantees the final result according to the customer expectations. It works for recognized companies both in Italy and abroad. More Design won the A' Design Award/Gold with the MY YOUR's Push Collection in 2022.



### Paolo De Lucchi

Paolo De Lucchi si laurea in Architettura al Politecnico di Milano nel 1989. Dopo 8 anni presso lo studio Sottsass Associati e Michele De Lucchi srl, apre a Padova la "delucchiworkshop.com" nel 1998. Come designer collabora con importanti aziende italiane nel settore illuminotecnico e progetta negozi in franchising, showrooms, stands nei settori moda, pelletteria e calzaturiero. Tiene corsi di formazione presso Università e Istituti professionali.

Paolo De Lucchi graduated in architecture at Politecnico di Milano in 1989. After 8 years at Sottsass Associati and Michele De Lucchi srl in Milan, opens in Padua the "delucchiworkshop.com" in 1998. As a designer collaborates with important Italian companies in the lighting sector and ideates franchise stores, showrooms, stands in the fashion, leather goods and footwear sectors. He holds training courses at universities and professional institutes.



### Brogliato Traverso

Brogliato Traverso è uno Studio di product design nato a Vicenza nel 2014. "NO TIME, NO SPACE" è il suo approccio al progetto: un segno dettagliato e leggero nel tempo. Brogliato Traverso lavora per varie aziende e annovera premi alcuni premi internazionali. Con MY YOUR vince il Good Design Award con Pandora e Mobi (2014, 2017) e il A' Design Award con Everyday e Ampoule nel 2014.

Brogliato Traverso is a product design Studio from Vicenza created in 2014 "NO TIME, NO SPACE" is its approach to the project: a detailed and light mark in time. Brogliato Traverso works for various companies and includes awards some international awards. With MY YOUR it wins the Good Design Award with Pandora and Mobi (2014, 2017) and the 2014 A' Design Award/Gold with Everyday and Ampoule.



### Simone Micheli

Nato nel 1964, si Laurea in Architettura Firenze e fonda il proprio Studio nel 1990. Nel 2003 apre la società di progettazione Simone Micheli Architectural Hero, insieme a Roberta Colla, con numerose sedi nel mondo. La sua attività è multidisciplinare e spazia dai master plan all'architettura e interior, dal product design alla grafica. Annovera progetti architettonici prestigiosi, è curatore di mostre e di eventi, tiene master, conferenze, workshop e lecture presso gli atenei di settore.

Graduated in architecture in Florence, he founded his own Studio in 1990 and the design company Simone Micheli Architectural Hero, together with Roberta Colla, with offices around the world, in 2003. His multidisciplinary activity ranges from master plans to architecture and interior, from product design to graphics. His work includes prestigious architectural projects, curatorship of exhibitions and events and speaking in master's degrees, conferences, workshops and lectures at universities.



### Ale Giorgini

Illustratore, fumettista, docente è riconosciuto internazionalmente per il suo tratto distintivo. Multinazionali, testate prestigiose, case di moda e di sportwears iconiche richiedono la sua collaborazione e creatività per distinguere e supportare i propri progetti di comunicazione visiva. Vince il Good Design Award con Mobi (Tales Collection) di MY YOUR nel 2017.

Illustrator, cartoonist, teacher is internationally recognized for its distinctive feature. Multinationals, prestigious magazines, fashion and iconic sportwears companies require his collaboration and creativity to distinguish and support their visual communication projects. He won the Good Design Award with MY YOUR's Mobi (Tales Collection) in 2017.





### Paolo Cappello

Laureato in Disegno Industriale presso il Politecnico di Milano, dopo una collaborazione triennale con Ludovica+Roberto Palomba, nel 2007 apre il proprio studio di design a Verona. Ha vinto numerosi premi internazionali di design tra cui "Young Designer talent" di EDIDA (2011) e Young and Design Award (2011, 2015). I suoi lavori sono stati esposti in molte esposizioni di design in tutto il mondo.

Graduated in Industrial Design at Politecnico di Milano, after a three-years collaboration with Ludovica+Roberto Palomba, in 2007 he setups his own design studio in Verona. He won many international design prizes including EDIDA's "Young Designer Talent" (2011) and Young and Design Award (2011, 2015). His works have been showcased in many design worldwide expositions.



### Isabella Lovero

Industrial Designer dal 2004, lavora per diversi marchi di arredamento. Nel 2007 ha fondato lo studio "en&is" al fianco di Enrico Bosa, creando nuove tipologie di oggetti come il megafono, l'amplificatore passivo iphone, che ha dato vita ad una startup che predilige la ceramica e il legno nel 2011. Dal 2013 è diventata titolare unica di "in&is" specializzata in design per l'elettronica. Dal 2017 insegna product design presso lo IED di Milano.

Industrial Designer since 2004, she works for several furniture brands. In 2007 she founded the "en&is" studio alongside Enrico Bosa, creating new types of objects such as megaphone, iphone passive amplifier, which gave life to a startup favouring ceramics and wood in 2011. From 2013 she became the unique owner of "in&is" specializing in design for electronics. From 2017 she is product design teacher at IED in Milan.



### Massimo Zaniboni

Massimo Zaniboni si laurea in Architettura presso il Politecnico di Milano nel 1994 con un progetto, in collaborazione con Pininfarina e il Centro Ricerche Fiat, che gli permette l'esperienza come designer in Piaggio Gilera a cui fanno seguito altre aziende automotive. Nel 1996 fonda Arkema Studio, producendo diversi prototipi di scooter, accessori e concept bike. Fra i riconoscimenti il "Ducati R&D Special Award". Oggi collabora anche con aziende di product e furniture design.

Massimo Zaniboni graduated in Architecture at the Politecnico di Milano in 1994 with a project, in collaboration with Pininfarina and the Fiat Research Center, which allows him the experience as a designer in Piaggio Gilera followed by other automotive companies. In 1996 he founded Arkema Studio, producing several prototypes of scooters, accessories and concept bikes. Among the awards the "Ducati R&D Special Award". Today he also collaborates with product and furniture design companies.



### Enrico Bosa

Enrico Bosa è un designer italiano, laureato al Politecnico di Milano, dove poi ha insegnato. Nei primi anni ha lavorato presso lo studio Stefano Giovannoni a Milano e nel 2007 ha fondato il proprio marchio "en&is" con Isabella Lovero. Tra il 2014 e il 2020 ha lavorato da Marcel Wanders come Project Leader e Direttore Creativo Associato/ Product Design. Vive e lavora ad Amsterdam e collabora con aziende italiane e internazionali.

Enrico Bosa is an Italian designer, graduated in Politecnico di Milano, where he later taught. He worked for his first years career at Stefano Giovannoni Studio in Milan and founded his own brand "en&is" in 2007 with Isabella Lovero. Between 2014 and 2020 he worked at Marcel Wanders as Project Leader and Associate Creative Director/Product Design. He currently lives and works in Amsterdam and collaborates with Italian and iconic international brands.



### Valerio Cometti

Valerio Cometti, Ingegnere Meccanico del Politecnico di Milano fonda "Valerio Cometti+V12 Design" nel 2005. Valerio Cometti e V12 Design iniziano a collaborare con brand italiani e internazionali molto noti in diversi settori: dall'elettronica di consumo ai musei aziendali, dal furniture design agli occhiali etc. lavorando su diverse consulenze come direzione creativa, design del prodotto e Deep Design Thinking.

Valerio Cometti, Mechanical Engineer from the Polytechnic of Milan establishes "Valerio Cometti+V12 Design" in 2005. Valerio Cometti and V12 Design started collaborating with very established Italian and international brands across different sectors: from consumer electronics to museums corporate, from furniture design to eyewear etc. working on different consultancies as creative direction, product design and Deep Design Thinking.



### Rosaria Copeta

Nata a Matera nel 1984, consegue la Laurea Magistrale Specialistica in Disegno Industriale e Comunicazione Visiva presso La Sapienza di Roma nel 2009. Menzione speciale al concorso "Young & Design" nel 2010 con il tavolo "LighTable", nel 2013 collabora con lo studio Gumdesign. Nel 2017 torna a Matera e apre il suo studio di industrial design. Dal 2019 è docente di product design presso L'istituto del Design di Matera.

Born in Matera in 1984, she graduated in Industrial Design and Visual Communication at La Sapienza in Rome in 2009. Special mention at the competition "Young & Design" in 2010 with the table "LighTable", in 2013 collaborates with the studio Gumdesign. In 2017 he returns to Matera and opens his own industrial design studio. Since 2019 she has been teaching product design at the Institute of Design in Matera.



### CrousCalogero

CrousCalogero è una società di consulenza di product design fondata da Francesc Crous e Alessandro Calogero nel 2009. Oggi rafforzano le loro collaborazioni con marchi internazionali di design, insegnano presso la scuola di design EINA di Barcellona e la Esdesign, Escuela Superior de Diseño de Barcelona. Il loro lavoro è riconosciuto con premi prestigiosi come il Delta d'Argento 2012 e la Selezione Delta 2014 e 2018.

CrousCalogero is a product design consulting company founded by Francesc Crous and Alessandro Calogero in 2009. Today they strengthen their collaborations with international design brands, teach at the EINA design school in Barcelona and the at the Escuela Superior de Diseño de Barcelona. Their work has been recognized with prestigious awards such as the Silver Delta 2012 and the Delta Selection 2014 and 2018.





# SAMURAI



Design by More Design





Samurai divano 8 posti, Samurai poltrona, Samurai tavolino, Aladdin tappeto - Extraordinary catalog  
Samurai 8 seats sofa, Samurai armchair, Samurai coffee table, Aladdin rug - Extraordinary catalog



## Samurai

Samurai è una collezione di sedute modulari outdoor dalle linee pulite ed essenziali ed è caratterizzata da una seduta ampia e bassa che ne implementa la leggerezza visiva. I braccioli e gli schienali, dalle forme contenute e aperte leggermente, accolgono i cuscini di seduta, aumentandone il comfort mentre i piedini sollevano e sostengono la struttura. Samurai si presenta in due versioni: Samurai Baseline con imbottitura in poliuretano e tessuto Sunbrella®, e Samurai Plusline con imbottitura in poliuretano, Dryfeel® e tessuto drenante Sunbrella®.

Samurai is a modular outdoor collection with clean and essential lines and is technically characterized by a wide and low seat that implements the visual lightness. The armrests and backrests, with small and slightly open shapes, welcome the seat cushions, increasing their comfort while the feet lift and support the structure. Samurai comes in two versions: Samurai Baseline with polyurethane padding and Sunbrella® fabric, and Samurai Plusline with polyurethane padding, Dryfeel® and Sunbrella® draining fabric.







Samurai poltrona, Samurai tavolino, Aladdin tappeto - catalogo Extraordinary  
Samurai armchair, Samurai coffee table, Aladdin rug - Extraordinary catalog





Samurai divano 3 posti, Samurai poltrona, Samurai tavolino, Pandora vasi S e M, Aladdin tappeto tondo - catalogo Extraordinary  
Samurai 3 seats sofa, Samurai armchair, Samurai coffee table, Pandora pots S and M, Aladdin round rug - Extraordinary catalog



Samurai tavolino sospeso  
Samurai hanging coffee table





2054



Design by Valerio Cometti + V12 Design











2054 divano imbottito 3 posti, 2054 poltrona imbottita, 2054 tavolino, Pandora vaso M, Aladdin tappeto - catalogo Extraordinary  
2054 upholstered 3 seats sofa, 2054 upholstered armchair, 2054 coffee table, Pandora pot M, Aladdin rug - Extraordinary catalog



## 2054

2054 è un sistema modulare di sedute e tavolini pensato tanto per l'indoor quanto per l'outdoor, che introduce un concetto molto versatile di modularità, infatti, un semplice aggancio permette di avere una poltrona singola o un divano componibile di lunghezza variabile. Il design, caratterizzato da linee morbide e da angoli arrotondati, è implementato dalla morbidezza di seduta. La struttura è in Poleasy®, mentre l'imbottitura di seduta è disponibile in ecopelle bianca.

2054 is a modular system of chairs and tables created for both indoor and outdoor, which introduces a very versatile concept of modularity, in fact, a simple hook allows you to have a single armchair or a modular sofa of variable length. The design, characterized by soft lines and rounded corners, is implemented by the softness of the seat. The Poleasy® structure is always white while the seat upholstery is available in white eco-leather.







2054 poltrona imbottita, 2054 tavolino, Aladdin tappeti - catalogo Extraordinary  
 2054 upholstered armchair, 2054 coffee table, Aladdin tappeti - Extraordinary catalog





Esempio di componibilità di tavolino e moduli 2054  
2054 coffee table and seats modularity example



# CHICO



Design by More Design





Chico divano 3 posti, Chico divano 2 posti, Chico poltrona, 2054 tavolino, tappeto Aladdin - catalogo Extraordinary  
Chico 3 seats sofa, Chico 2 seats sofa, Chico armchair, 2054 coffee table, Aladdin rug - Extraordinary catalog



## Chico

Chico è un sistema di sedute modulari per outdoor che permette di creare diverse composizioni per rispondere alle esigenze di spazio e personalizzazione, sia in ambito residenziale che contract. La struttura, in Poleasy®, ricorda l'imbottitura capitonné dei divani classici del Novecento mentre il design squadrato e aperto esalta questa caratteristica in modo identificativo, elegante e borghese. Disponibile in varie finiture, con cuscino di seduta a complemento, è facile da pulire e da mantenere a cielo aperto.

Chico is a modular seating system for outdoor that allows you to create different compositions to meet the needs of space and customization, both in residential and contract areas. The structure, made in Poleasy®, is reminiscent of the twentieth century quilted upholstery classic sofas while the square and open design enhances this characteristic in an identifying, elegant and bourgeois way. Available in various finishes, with seat cushion to complement, it's easy to clean and keep in the open-air.







Chico divano 3 posti, Chico poltrona, 2054 tavolino, tappeto Aladdin - catalogo Extraordinary  
Chico 3 seats sofa, Chico armchair, 2054 coffee table, Aladdin rug- Extraordinary catalog





Poltrona Chico  
Chico armchair



# NOVA



Design by Brogliato Traverso





Nova divano 2 posti con cuscini TE, 2054 tavolino, Agata Wood lampada da terra, Aladdin tappeto - catalogo Extraordinary  
Nova 2 seats sofa with TE cushions, 2054 coffee table, Agata Wood standing lamp, Aladdin rug - Extraordinary catalog





Nova poltrona con cuscini TE, 2054 tavolino  
Nova armchair with TE cushions, 2054 coffee table







Nova divano 2 posti con cuscini TE, Nova poltrona con cuscini TE, 2054 tavolino, Aladdin tappeto - catalogo Extraordinary  
Nova 2 seats sofa with TE cushions, Nova armchair with TE cushions, 2054 coffee table, Aladdin rug - Extraordinary catalog





### Nova

Pensata per l'outdoor la collezione Nova è capace di sintetizzare sapientemente volumi sinuosi ed eleganza minimale, in un perfetto comfort funzionale. Il design curvo è identificativo e richiama spazi all'aria aperta in cui farsi avvolgere dalla sue linee. Le sedute dei divani sono in due altezze differenti, mentre la poltrona è disponibile solo nella versione S. Tutti i moduli sono in Poleasy®, abbinabili al tavolino 2054 e al loro cuscino accessorio di seduta.

Designed for outdoor use, the Nova collection is able to expertly synthesize sinuous volumes and minimal elegance, in perfect functional comfort. The curved design is identifying and recalls open-air spaces in which to be enveloped by its lines. The sofas seats are in two different heights, while the armchairs are only available in the S version. All the modules are in Poleasy, which can be combined with the 2054 table and their seat accessory cushions.









Nova divano XL con cuscino TE, Nova panca, 2054 tavolino, Agata Wood lampada da terra  
Nova XL sofa with TE cushion, Nova bench, 2054 coffee table, Agata Wood standing lamp





Esempio di componibilità di panca Nova  
Nova bench modularity example



LILY

LILY

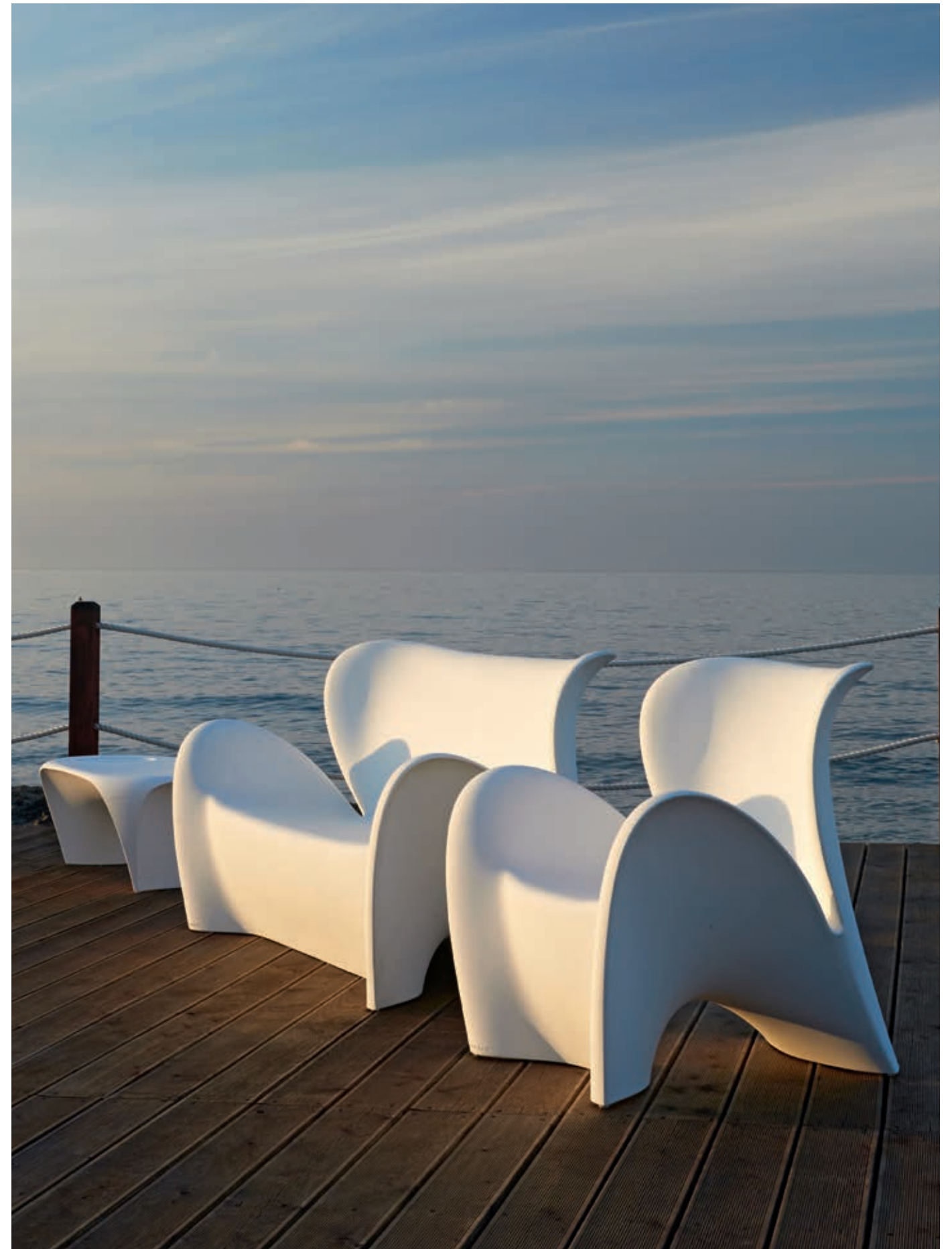

Design by More Design







## Lily

Lily è una collezione composta da sedute di diverse misure e dal tavolino con o senza spumantiera. Forte e poetica, è disegnata da More Design. Il cuore del progetto Lily è il design organico a simulare il petalo di un fiore che sfida le tecniche di ingegnerizzazione. Una proposta outdoor polivalente, elegante e confortevole del concetto living e dining. È disponibile la versione illuminabile per il tavolino e il cuscino di seduta a complemento di divani, poltrone e sedie per rendere l'utilizzo ancora più rilassante e avvolgente, ovunque Voi siate.

Lily is a collection composed of seats in different sizes and a coffee table with or without wine-cooler. Strong and poetic, it is designed by More Design. At the heart of the Lily project is the organic design that simulates the petal of a flower that challenges engineering techniques. A multifunctional outdoor proposal, elegant and comfortable living and dining concept, It is available the lighted version for the coffee table and the seat cushion as accessory for sofas, armchairs and chairs to make the use even more relaxing and enveloping, wherever you are.







Lily tavolino con ice-box, Lily divano 2 posti con cuscino TE  
Lily coffee table with ice-box, Lily 2 seats sofa with TE cushion



# MODI`

MODI`



Design by More Design









### Modi

Modi è un sistema modulare di sedute e complementi outdoor che si trasforma in varie configurazioni e adattabile a ogni spazio. Partendo progettualmente da un'unica base rettangolare in Poleasy®, la modularità è composta da: seduta, bracciolo/schienale, angolo e piano in vetro. Aggiungendo alla base il piano in vetro, inoltre, la collezione Modi si completa con il suo tavolino. È disponibile con rivestimento di seduta in ecopelle bianca per esterni e in tonalità bianca o nera per la struttura di base.

Modi is a modular system of outdoor seating and complements that is transformed into various configurations and adaptable to any space. Starting from a single rectangular Poleasy® base, the modularity consists of: seat, armrest/ back, corner and glass top. Moreover, by adding the glass top to the base, the Modi collection is completed with its coffee table. It is available with seat cover in white eco-leather for outdoor use and in white or black tones for the basic structure.



# COMMUNITY SET

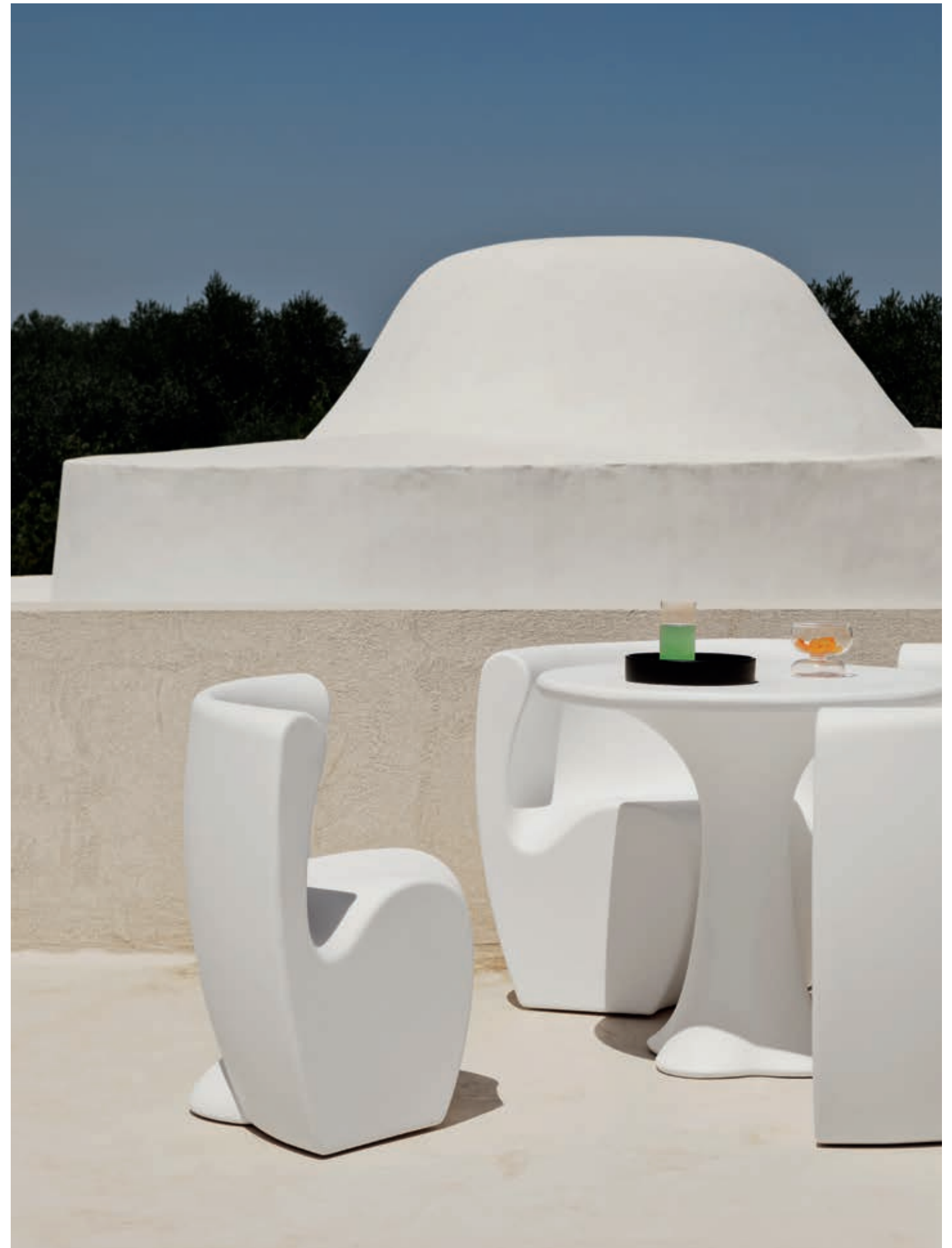

Design by More Design





Community Set: poltroncine da pranzo Rhonda e tavolo da pranzo Teddy  
Community Set: Rhonda dining armchairs and Teddy dining table





### Community Set

Tavoli e sedie si fondono in un'unica forma, così Community Set diventa metafora dell'aggregazione che stimola, grazie ad atmosfere informali e amichevoli. Il cuore del progetto è l'idea che quattro sedute possano racchiudere un tavolo eliminandone la distanza dal piano.

Ideale per il settore contract, risponde a qualsiasi esigenza di spazio poichè si adatta a dimensioni contenute. Il design curvo crea forme semplici, uniche forme elegantemente distintive che lo rendono esteticamente avvolgente sia nella versione chiusa, sia nella versione aperta. Community Set è composto da quattro poltrone da pranzo Rhonda e dal tavolo da pranzo Teddy.

Tables and chairs come together in a single form, so Community Set becomes an aggregation metaphor that stimulates, thanks to informal and friendly atmospheres. The project idea is that four seats can enclose a table eliminating the distance from the top. Perfect for the contract sector, it meets any space requirement as it adapts to small dimensions. The curved design creates simple shapes, unique forms elegantly distinctive that make it aesthetically enveloping both in the closed version and in the open version. Community Set consists in four Rhonda dining armchairs and iTeddy dining table S.





Community set: poltroncine da pranzo Rhonda e tavolo da pranzo Teddy luminoso  
Community set: Rhonda dining armchairs and Teddy light dining table



# MISS PETRA

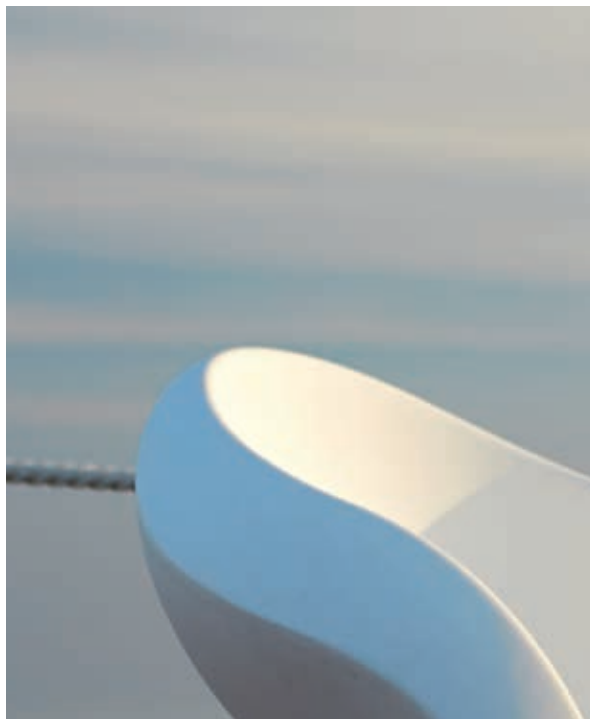

Design by More Design





Miss Petra poltrona  
Miss Petra armchair



### Miss Petra

Con le sue curve avvolgenti Miss Petra sfida la gravità con una resistenza insuperabile. La sua morbidezza nasconde una struttura monoblocco potente, uno sviluppo industriale attento e un design confortevole. La sua forma a conchiglia arrotondata e accogliente le conferisce un aspetto rassicurante e coinvolgente. Interamente in Poleasy®, riciclabile al 100%, è perfetta per spazi indoor e outdoor dalla forte personalità.

With her wrap-around curves Miss Petra challenges gravity with an unsurpassed resistance. Its softness hides a powerful monobloc structure, careful industrial development and comfortable design. Its rounded and welcoming shell shape gives it a reassuring and engaging look. Made entirely of 100% recyclable Poleasy®, it's perfect for indoor and outdoor spaces with a strong personality.





# MR LEM



Design by More Design







### Mr Lem

L'ispirazione dello sgabello Mr Lem, progettato da More design per MY YOUR, è una navicella spaziale e il primo sbarco sulla luna. Linee decise, figura semplice, senza perdere di vista gli aspetti pratici del trasporto e della componibilità, che permettono di sistemare due pouf nell'ingombro di uno, grazie alla sua simmetria. Realizzato in Poleasy® si adatta ad ambienti indoor e outdoor in cui sia necessario progettualmente uno o più complementi che aiutino a caratterizzarli in modo identitario, brioso e minimale.

The inspiration of the Mr Lem stool, designed by More Design for MY YOUR, is a spaceship and the first landing on the moon. Strong lines, simple figure, without losing sight of the practical aspects of transport and modularity, which allow you to place two poufs in the bulk of one, due to its symmetry. Made in Poleasy®, suitable for indoor and outdoor environments where it is necessary to design one or more complements that help to characterize them in an identity, lively and minimal.







Mr Lem nelle varianti colore  
Mr Lem colour palette



# BART



Design by More Design







### Bart

Simbolo di moda e tendenza, lo sgabello Bart si presta a differenti soluzioni d'arredo, grazie alla sua linea ergonomica, e si presenta in un design morbido e stilisticamente adattabile.

Per sua natura è ideale per locali alla moda, per eventi, per conventions o, semplicemente, per il proprio spazio privato indoor o outdoor in cui inserirlo. Abbinato al tavolo Teddy diviene seduta a tutti gli effetti e crea un mood contemporaneo e non convenzionale, in cui vivere la propria convivialità.

Symbol of fashion and trend, the Bart stool lends itself to different furnishing solutions, thanks to its ergonomic line, and is presented in a soft and stylistically adaptable design. By its nature it is ideal for trendy venues, events, conventions or simply for your own private indoor or outdoor space in which to place it. Combined with Teddy table becomes a seat in all respects and creates a contemporary and unconventional mood, in which to live your conviviality.





# PANDORA



Design by Brogliato Traverso





Pandora sgabelli S e M, Pandora tavolino  
Pandora S and M stools, Pandora coffee table



## Pandora

E' la natura ad ispirare le forme della collezione Pandora, il cui pattern ne enfatizza la personalità. Il progetto di Brogliato Traverso è infatti multisensoriale: da un'iconica forma ellissoide a sezione circolare, si enfatizza il tatto in modo estremamente gradevole attraverso il decoro a righe concentriche e tridimensionali. Un oggetto semplice, destinato a durare nel tempo, disponibile sia nella versione sgabello in tre misure sia il quella a tavolino si decanta in nuances dalle molte tonalità.

Nature inspires the Pandora collection shapes, whose pattern emphasizes its personality. The project by Brogliato Traverso is in fact multisensory: from an iconic ellipsoid shape to circular section, it emphasizes the touch in an extremely pleasant way through the decoration of concentric and three-dimensional stripes. A simple object, intended to last over time, available both in three sizes stool and in the coffee table version, is highlighted in nuances of many shades.







Pandora sgabello M, Teddy tavolo da pranzo  
Pandora M stools, Teddy dining table



# OXFORD



Design by Brogliato Traverso





Oxford tavolo, Oxford sgabelli e Agata Wood lampada da terra  
Oxford table, Oxford stools and Agata Wood standing lamp





### Oxford

Oxford sgabello, grazie alle sue forme morbidamente geometriche, dissimula il materiale plastico di cui è composto ricordando la classica forma dello sgabello treppiede in legno. Oxford tavolo, con fusto a tre razze e piano in Poleasy®, è alto 110 cm e ideale per il settore contract e hotellerie. Lo smontaggio delle gambe assicura, inoltre, un contenuto volume di trasporto e stoccaggio. Entrambi i prodotti, disegnati da Brogliato Traverso, sono versatili e funzionali alla progettazione di ambienti lounge e dining dal carattere distintivo.

Oxford stool, thanks to its softly geometric shapes, conceals the plastic material of which it's made recalling the classic shape of the wooden tripod stool. Oxford table, with Poleasy® a three spokes stem and top, is 110 cm high and perfect for the contract and hotel sector. The dismantling of the legs also ensures a low volume of transport and storage. Both products, designed by Brogliato Traverso, are versatile and functional for distinctive lounge and dining spaces design.



# LIBERTY



Design by More Design





Liberty tavolo XL, Liberty sgabelli L  
Liberty XL table, Liberty L stools





### Liberty

La vivacità di Liberty nasce dal gioco dei vuoti e dei pieni. Gli ampi fori cavi della struttura esaltano, con la loro asimmetria, l'energia della superficie bicolore. La collezione Liberty denota una forte personalità pop attraverso il binomio cromatico dei materiali e un design organico e funzionale che ne evidenzia le caratteristiche. Perfettamente impilabili, sgabelli e tavoli Liberty arredano e liberano lo spazio con un originale tocco di design. Ideali per il settore contract, per eventi, per locali e ristoranti, resistono agli agenti atmosferici nel tempo e sono facili da mantenere.

The Liberty liveness comes from the play of the empty and full spaces. The large hollow holes of the structure enhance, with their asymmetry, the energy of the two-tone surface. The Liberty collection denotes a strong pop personality through the chromatic combination of materials and an organic and functional design that highlights its characteristics. Perfectly stackable, Liberty stools and tables furnish and free the space with an original design touch. Perfect for the contract sector, for events, for clubs and restaurants, they resist the weathering and are easy to maintain.



# NOVA BANCONE

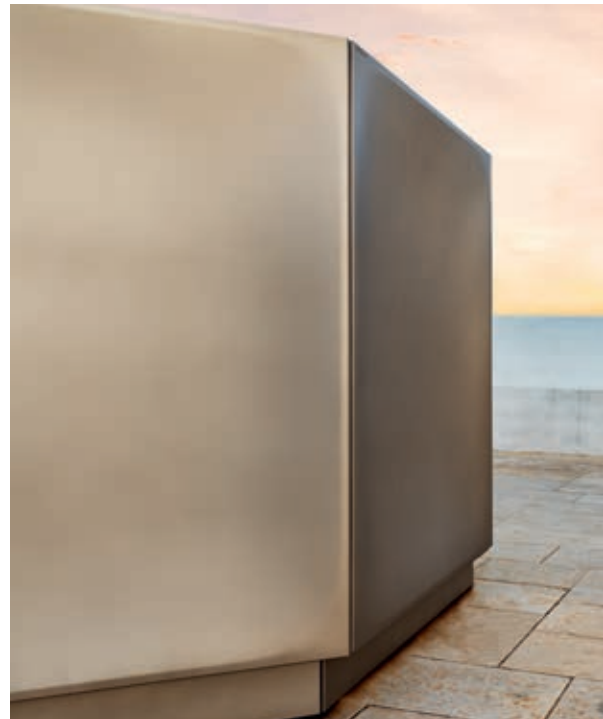

Design by Brogliato Traverso







Nova bancone luminoso  
Nova light counter





Nova bancone luminoso, Oxford sgabelli  
Nova light counter, Oxford stools



### Nova Bancone

MY YOUR implementa la collezione Nova con il bancone, in due versioni, dal design elegante e dalla versatilità sorprendente. Senza luce, illuminato o con la finitura OV, il bancone Nova impreziosisce il luogo che lo accoglie, senza appesantire lo sguardo di chi si serve. La sua cocktail station dedicata, infine, permette di gestire gli ingredienti di food and beverage necessari per accendere le grandi serate di festa.

MY YOUR implements the Nova Collection with the counter, in two versions, with an elegant design and surprising versatility. Without light, illuminated or in the OV finishing, the Nova counter embellishes the place that welcomes it, without weighing down the look of those who use it. Its dedicated cocktail station, finally, allows you to manage the food and beverage ingredients needed to turn on the big party nights.







Nova bancone con cocktail station  
Nova counter with cocktail station



# DUBLIN

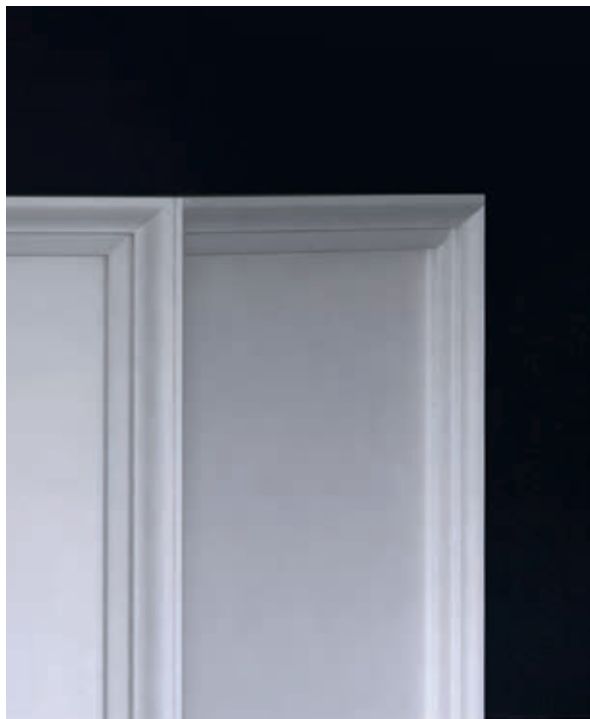

Design by Brogliato Traverso





Dublin bancone luminoso  
Dublin light counter





## Dublin

Dublin è all'occorrenza postazione bar, modulo cassa e/o reception, le cui forme si ispirano ai banconi dei pub irlandesi in stile Art Decò. I fianchi richiudibili per il modulo lineare, la possibilità di personalizzazione del fronte, i diversi tipi di illuminazione e la sua maneggevolezza rendono Dublin uno strumento efficacemente funzionale per locali, hotel, ristoranti, bar ed eventi. Dublin è disponibile in eleganti nuances monocromatiche e nella versione luminosa per le occasioni di tendenza.

Dublin is available as a bar, cash desk and/or reception, whose shapes are inspired by Irish pubs Art Deco counters. The foldable sides for the linear module, the possibility of front customization, the different types of lighting and its handling make Dublin an effectively functional tool for hotels, restaurants, bars and events. Dublin is available in elegant monochrome shades and in the luminous version for your hip parties.





Dublin interno del modulo bar e componibilità angolare  
 Dublin inside bar element and corner modularity





Dublin bancone in finitura copper OS  
Dublin OS copper finishing counter



# BARAONDA

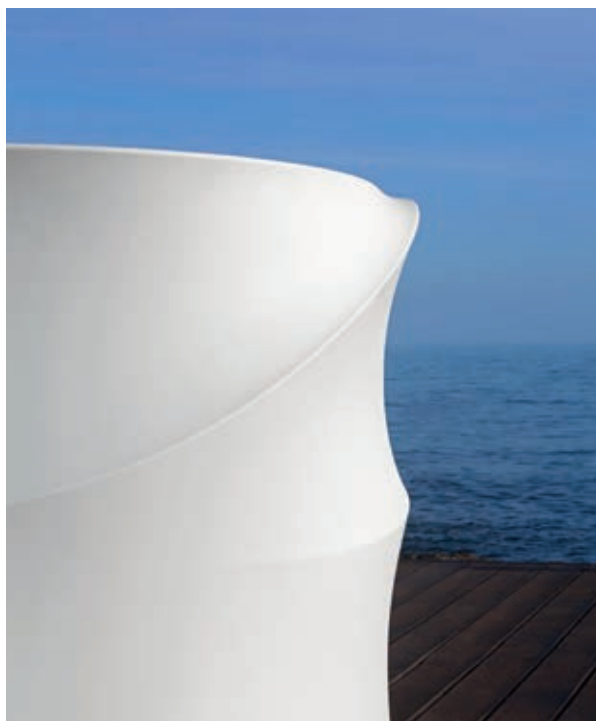

Design by More Design

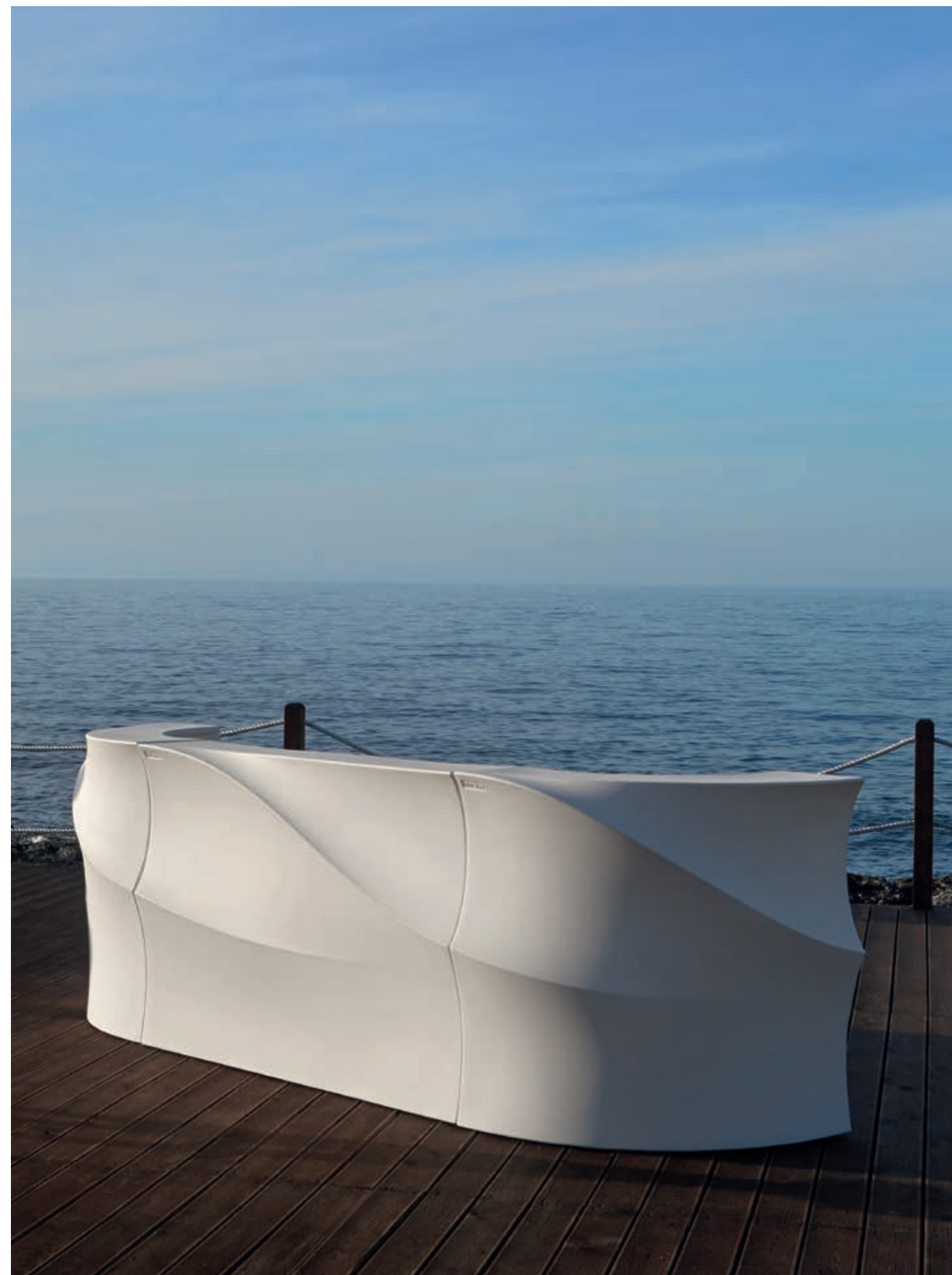





Baraonda bancone luminoso e Display contenitore retrobanco luminoso  
Baraonda light counter and Display light storage back-counter



## Baraonda

L'idea da cui nasce Baraonda di MY YOUR è un'onda sinuosa che avvolge un bancone e che si compone liberamente in svariati multipli e colori. In versione luminosa e non, trasportabile ovunque, facilmente richiudibile e stoccabile, Baraonda nel corso del tempo è diventato un'icona estetica e funzionale nel suo target di riferimento. La grande ed elegante personalità fanno di Baraonda un elemento di design unico e personalizzabile in grado di accendere le infinite sfumature della festa. La funzionalità di Baraonda viene implementata dal contenitore retrobanco Display, anch'esso illuminabile, per l'appoggio di bottiglie e materiali d'utilizzo.

The MY YOUR's Baraonda concept is a sinuous wave that wraps around a counter and is freely composed by several multiples and colors. In the luminous and not version, transportable everywhere, easily resealable and storable, Baraonda over time has become an aesthetic and functional icon in its target audience. The great and elegant personality make Baraonda a unique and customizable design element able to turn on the endless party shades. The Baraonda functionality is implemented by the Display storage back counter, which can also be illuminated, to support bottles and materials.





Display contenitore retrobanco luminoso  
Display light storage back-counter





# KITE



Design by More Design









## Kite

Kite è la copertura per esterni che non ti aspetti. Messa a punto da MY YOUR R&D è ideale per ospitare feste in giardino, per i locali ed eventi di qualsiasi tipo. In due dimensioni, si può comporre in multipli per la realizzazione di grandi coperture. Il design della vela è composto da aree a perimetro triangolare che permettono stabilità in caso di maltempo. La sua struttura è elegantemente solida e i materiali utilizzati sono resistenti agli agenti atmosferici e all'utilizzo nel tempo.

Kite is the sun cover you don't expect. Developed by MY YOUR R&D is perfect for hosting garden parties, for venues and events of any kind. In two sizes, it can be composed in multiples for the realization of large roofs. The sail design is composed by areas with triangular perimeter that allow stability in bad weather. Its structure is elegantly solid and the materials used are resistant to weathering and use over time.



Kite copertura, Baraonda bancone luminoso, Display contenitore retrobanco luminoso  
Kite sun cover, Baraonda light counter, Display light storage back-counter





# FLAMINGO



Design by More Design







## Flamingo

Lidi, piscine, discoteche, ristoranti, hotel e tutti gli spazi legati alla collettività necessitano di creare percorsi per gestire i flussi e garantire accessibilità e distanze di sicurezza. MY YOUR ha chiesto a More Design un prodotto gradevole, fruibile ed efficace per questa necessità.

Flamingo è un sistema divisorio in multipli che permette di perimetrare gli spazi creando percorsi agili e di dividere gli stessi in modo personalizzato. Alla base una zavorra che evita il fissaggio a terra e ne permette facilmente il posizionamento. Flamingo è interamente realizzato in Poleasy® e dotato di supporti per segnaletica e dispenser.

Beaches, swimming pools, nightclubs, restaurants, hotels and all the spaces linked to the community need to create paths to manage flows and ensure accessibility and safe distances.

MY YOUR asked More Design for a pleasant, usable and effective product for this need. Flamingo is a partition system in multiples that allows you to perimeter the spaces creating agile paths and divide them in a personalized way. At the base a ballast that avoids fixing to the ground and allows easy positioning. Flamingo is entirely made of Poleasy® and equipped with supports for signage and dispensers.





# NON VASO



Design by Massimo Zaniboni





Non Vaso fioriera/ divisorio luminoso, Dublin bancone luminoso, Oxford tavolo, Oxford sgabello  
Non Vaso light planter/ divider, Dublin light counter, Oxford table, Oxford stool





### Non Vaso

Essere o non essere un vaso? L'ironica parafrasi di Shakespeare, a cui si è infine data risposta, rimanda a un'idea di progetto dalle molteplici possibilità. Il vuoto dello spazio libero, ispiratore della forma, surreale rende questo separatore un oggetto presente, concreto e modulare. Disegnato da Massimo Zaniboni intorno alla forma archetipo di vaso, consente sia l'inserimento decorativo di piante e fiori sia la funzione di divisorio o di cinto perimetrale. Realizzato in Poleasy®, è disponibile anche in versione luminosa.

To be or not to be a vase? The Shakespeare ironic paraphrase, which was finally answered, refers to a project idea of multiple possibilities. The void of free space, the inspiration of the surreal form, makes this divider an object present, concrete and modular. Designed by Massimo Zaniboni around the archetypal vase shape, it allows both the decorative insertion of plants and flowers and the function of a partition or perimeter wall. Made of Poleasy®, it's also available in luminous version.



# FRAMES

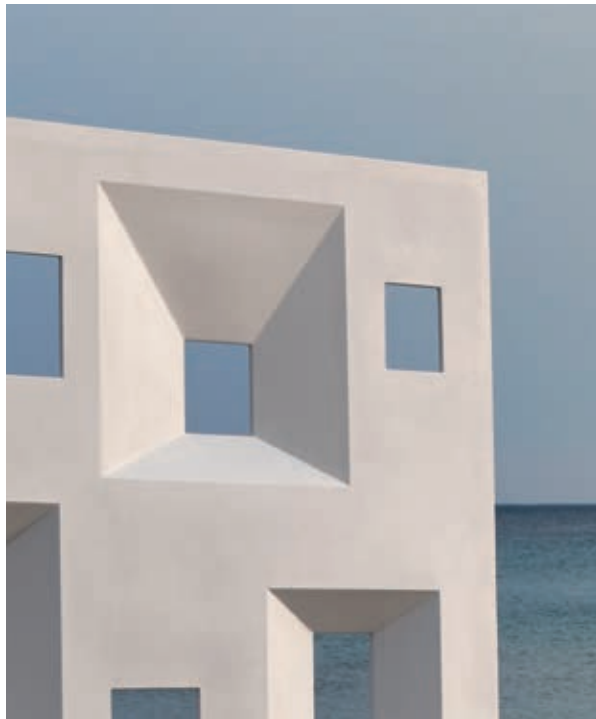

Design by Brogliato Traverso

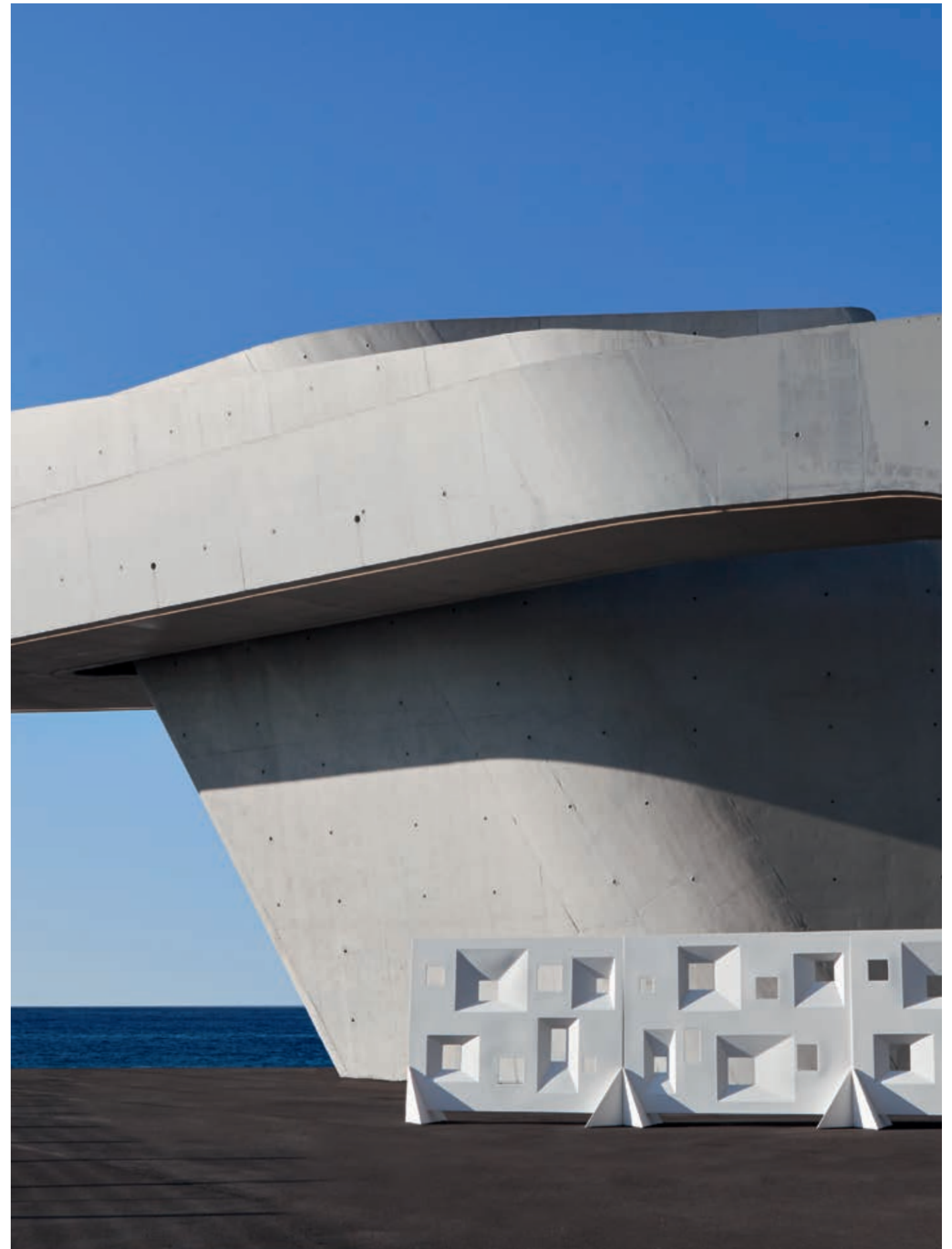





Frames divisorio, 2054 divano 3 posti, 2054 poltrona, Pandora tavolino  
Frames divider, 2054 3 seats sofa, 2054 armchair, Pandora coffee table



## Frames

Frames è un modulo zavorrato con funzione di separatore e di delimitatore di spazi sia in posizione orizzontale che verticale. Il decoro è caratterizzato da superfici svasate che fungono da cornice a vuoti decorativi. Come piccole finestre, i decori creano scorci geometrici in cui guardare. Brogliato Traverso ha immaginato questo progetto per MY YOUR con il fine di creare un rapporto visivo fra le aree delimitate da Frames e ampliare la vista all'interno dello spazio delimitato. Efficiente, bello e facilmente trasportabile, è testato

Frames is a ballasted module with the separator and delimiting spaces function both in horizontal and vertical position. The decor is characterized by flared surfaces that serve as a frame to decorative voids. Like small windows, the decorations create geometric glimpses in which to look. Brogliato Traverso imagined this project for MY YOUR in order to create a visual relationship between the Frames delimited areas and expanding the view within the delimited space. Efficient, beautiful and easily transportable, it's tested for weathering in time.





# BA\_GIGIO



Design by Simone Micheli





Ba\_Gigio divisorio, Cloe lettino  
Ba\_Gigio divider, Cloe sunbed





### Ba\_Gigio

Un elemento componibile senza limiti a rappresentazione tridimensionale del simbolo dell'infinito, nato dalla rivoluzione dello stesso intorno al proprio asse e come macroimmagine spaziale di un legame atomico bipolare. Questo il pensiero dell'Arch. Simone Micheli intorno a questo progetto per MY YOUR. Ba\_gigio è separatore, cinta perimetrale ed elemento decorativo scultoreo. In diverse modularità ed altezze, Ba\_gigio è disponibile nella versione full white.

A modular element without limits to three-dimensional representation of infinity symbol, born from its revolution around its axis and as a spatial macroimage of a bipolar atomic bond. That's the Arch. Simone Micheli's idea of this project for MY YOUR. Ba\_Gigio is a divider, a perimeter wall and a sculptural decorative element. Ba\_gigio is available in a full white version in different sets and heights.



# CLOE



Design by More Design







Cloe lettino  
Cloe sunbed





### Cloe

Cloe è uno dei prodotti icona di MY YOUR. Disegnato da More Design, Cloe è un lettino dalle curve morbide, suadenti e confortevoli. Il suo nome, utilizzato dagli antichi greci per la dea Demetra, significa "giovane" e "fresco", esattamente come si presenta il suo design unico e scultoreo. Realizzata in Poleasy® e studiata per una collocazione in ambienti esterni, di facile manutenzione, Cloe resiste all'acqua ed ai raggi UV.

Cloe is one of the MY YOUR's iconic products. Designed by More Design, Cloe is a bed with soft, charming and comfortable curves. Its name, used by the ancient Greeks for the goddess Demeter, means "young" and "fresh", exactly as its unique and sculptural design. Made of Poleasy® and designed for outdoor use, easy to maintain, Cloe resists water and UV rays.



Cloe lettino  
Cloe sunbed





# ZOE



Design by More Design





Zoe lettino  
Zoe sunbed





## Zoe

Il lettino Zoe rappresenta la naturale evoluzione di Cloe. Il plus è schienale reclinabile a pulsante che consente un comfort superiore. I dettagli sono curati in modo eccellente per garantire un relax aumentato. Il design del lettino Zoe si integra armoniosamente con il sistema di regolazione dello schienale attraverso l'impiego di un pistone a gas azionabile da un semplice pulsante. La scocca in Poleasy® contiene dispositivi metallici interamente cromati che garantiscono una lunga totale resistenza agli agenti atmosferici.

The Zoe sunbed represents the Cloe natural evolution. The plus is the push-button reclining backrest that allows a superior comfort. The details are treated excellently to ensure increased relax. Zoe sunbed design integrates harmoniously with the backrest adjustment system through the use of a gas piston operated by a simple button. The Poleasy® shell contains fully chromed metal devices that guarantee a long total resistance to atmospheric agents.



# NOVA LETTINO



Design by Brogliato Traverso







Nova lettino  
Nova sunbed





### Nova lettino

Nova lettino è caratterizzato da dimensioni generose e linee coerenti con tutta la collezione Nova. Realizzato in Poleasy®, riciclabile al 100%, disponibile con materassino in tessuto per esterni, presenta smussi angolari che ne amplificano il design e la sicurezza. Lo schienale reclinabile permette di definire l'inclinazione più confortevole mentre le ruote ne garantiscono la facile movimentazione. Tutti i materiali sono idrorepellenti, di facile pulizia e resistenti ai raggi UV.

Nova sunbed is characterized by generous dimensions and lines consistent with the entire Nova collection. Made of 100% recyclable Poleasy®, available with outdoor fabric mattress, it has angular bevels that amplify the design and safety. The reclining backrest allows you to define the most comfortable inclination while the wheels ensure easy handling. All materials are water-repellent, easy to clean and UV resistant.





Nova lettino, Nova divano XL, Nova panca  
Nova sunbed, Nova XL sofa, Nova bench



# BALI



Design by MY YOUR R&D





Bali lettino, Bali tavolino  
Bali sunbed, Bali side table





## Bali

Se pensiamo a Bali, pensiamo proprio all'isola indonesiana, MYYOUR comunica la serenità ed il comfort che solo un beach set, composto da lettino, tavolino e ombrellone può dare. Il lettino Bali è impilabile fino a 14 unità con uno schienale regolabile in 5 posizioni. Il tessuto in poliestere e PVC, abbinato alle nuances di struttura in polipropilene, resiste ai raggi UV e agli agenti atmosferici. La collezione BALI è completata dall'ombrellone in tessuto acrilico con struttura in acciaio. Disponibile in 2 versioni: tondo dal diametro di 2,5 m oppure quadrato con lato di 2 m.

If we imagine Bali, we think about the Indonesian island, MYYOUR communicates the serenity and comfort that only a beach set consisting of a bed, table and umbrella can give. The Bali bed is stackable up to 14 units with a backrest adjustable in 5 positions. The polyester and PVC fabric, combined with polypropylene structure shades, resists UV rays and weathering. The BALI collection is completed by the sun-umbrella in acrylic fabric with steel structure. Available in 2 versions: round with a 2.5 m diameter or square with a 2 m side.



# DYNO



Design by More Design





Dyno doccia, Paw base per doccia, Nova lettino  
Dyno shower, Paw shower base, Nova sunbed





## Dyno

Una forte personalizzazione del giardino e del bordo piscina sono gli obiettivi che hanno guidato MY YOUR nel progetto della doccia per esterni Dyno. Disegnata da More Design, dalle forme sinuosamente ergonomiche, è disponibile in bianco nella versione gofrata stampata. La base Paw realizzata in ABS è dotata di profili per trattenere la sabbia ed è rivestita con un film acrilico che rende più efficaci, comode e sicure le operazioni di pulizia. Dyno è uno dei prodotti in Poleasy® più distintivi di MY YOUR.

A strong customization of the garden and the pool are the objectives that guided MY YOUR in the Dyno outdoor shower project. Designed by More Design, with sinuously ergonomic shapes, it's available in white printed embossed version. The Paw base, made of ABS, is equipped with profiles to retain the sand and is coated with an acrylic film that makes cleaning operations more effective, comfortable and safe. Dyno is one of the most MY YOUR's Poleasy® distinctive products.



# GEM



Design by Paolo Cappello





Gem vaso M, Gem fioriera/ ice-box  
Gem M pot, Gem planter/ ice-box



## Gem

I vasi Gem, disegnati da Paolo Cappello per MY YOUR, si ispirano al taglio delle pietre preziose. Questo elemento di design caratterizza tutti i modelli proposti che, come monoliti minimali e raffinati, diventano protagonisti funzionali dello spazio in cui si trovano. Realizzati in Poleasy® in tre formati, se appaiati, possono creare un infinito divisorio o un cinto perimetrale con differenti possibilità di composizione. Disponibili anche in versione luminosa e nella finitura Velvet, i vasi Gem sono testati per resistere ai raggi UV e agli agenti atmosferici.

The Gem vases, designed by Paolo Cappello for MY YOUR, are inspired by the cut of precious stones. This design element characterizes all the proposed models that, like minimal and refined monoliths, become space functional protagonists in which they are located. Made of Poleasy®, in three sizes, if paired, they can create an infinite partition or perimeter belt with different possibilities of composition. Also available in a light version and in the Velvet finishing, Gem vases are tested to withstand UV rays and weathering.





Gem vasi S e M, Gem fioriera/ ice-box luminosi  
Gem S and M light pots, Gem planter/ ice-box





# PANDORA POTS



Design by Brogliato Traverso











### Pandora Pots

Pandora Pots sono i vasi in tre dimensioni che completano la collezione Pandora disegnata da Brogliato Traverso per MY YOUR. Le forme minimali ed elegantemente sinuose, il pattern lineare a rilievo e la morbidezza al tatto conferiscono a questi prodotti la totale versatilità di utilizzo. Lo spazio in cui si trovano, infatti, è decorato e sottolineato in modo sempre borghese. Realizzati in Poleasy®, disponibili nella versione gofrata stampata, direct painting e luminosa, si mantengono facilmente e resistono agli agenti atmosferici.

Pandora Pots are the vases in three sizes that complete the Pandora collection designed by Brogliato Traverso for MY YOUR. The minimal and elegantly sinuous shapes, the linear pattern in relief and the softness to the touch give these products the total versatility of use. The space in which they are, in fact, is decorated and emphasized in an always bourgeois way. Made of Poleasy®, available in embossed printed, direct painting and luminous, they are easily maintained and resist atmospheric agents.



# SKIN



Design by Isabella Lovero + Enrico Bosa







Skin vasi S e L, Community set  
Skin S and L pots, Community set





### Skin

Skin è una serie di vasi dalla forma elegantemente neoclassica disegnata da Isabella Lovero ed Enrico Bosa. Il design si evidenzia attraverso la texture tridimensionale che ne enfatizza lo stile e la morbidezza al tatto. Con funzione decorativa, sono utilizzabili singolarmente o in composizione nelle tre dimensioni disponibili. Luminosi, ossidati e nelle nuances GS, decorano ogni spazio in modo ricco, distintivo e borghese.

Skin is a series of elegantly neoclassical vases designed by Isabella Lovero and Enrico Bosa. The design is highlighted by the three-dimensional texture that emphasizes the style and softness to the touch. With decorative function, they can be used individually or in set available in three sizes. Luminous, oxidized and in GS shades, they decorate every space in a rich, distinctive and bourgeois way.



Skin vasi S e L luminosi  
Skin S and L light pots







Design by Rosaria Copeta







## Tao

Tao è una linea di vasi che sfida la geometria, ispirandosi ai concetti ritmici dello yin e dello yang. Rosaria Copeta disegna per MY YOUR tre forme curve, in grado di incastrarsi perfettamente fra loro a comporre un unico monolite scultoreo seguendo il design del simbolo orientale.

I vasi Tao sono liberamente accostabili fra loro e disponibili nelle finiture Velvet e gofrata stampata. Realizzati in Poleasy®, al 100% riciclabili, sono testati per resistere nel tempo agli agenti atmosferici.

Tao is a pot collection that challenges geometry, inspired by the yin and yang rhythmic concepts. Rosaria Copeta designs for MY YOUR three curved shapes, able to fit perfectly together to compose a single sculptural monolith following the design of the oriental symbol.

Tao pots can be freely combined and are available in Velvet and embossed printed finishes. Made of 100% recyclable Poleasy®, they are tested to withstand the weather.





# TINO



Design by Isabella Lovero + Enrico Bosa







Tino sedia per bambini  
Tino kids chair





### Tino

Tino è una sedia indoor-outdoor per bambini che sia anche gioco con una forma riconoscibile. Tino evoca l'infanzia nei suoi valori più puri. Il design di Isabella Lovero ed Enrico Bosa per MY YOUR coniuga tutti questi aspetti creando una sedia-elefantino la cui proboscide, rivolta verso l'alto, diventa schienale. Disponibile anche luminoso, questo prodotto in Poleasy® si distingue per il suo aspetto magicamente unico e beneaugurante. Facile da pulire, resiste ai raggi UV e agli agenti atmosferici.

Tino is an indoor-outdoor chair for children that is also game with a recognizable shape. Tino evokes childhood in its purest values. The Isabella Lovero and Enrico Bosa's design for MY YOUR combines all these aspects creating a chair-elephant whose trunk, facing upwards, becomes the back. Also available in light version, this product in Poleasy® stands out for its magically unique and auspicious appearance. Easy to clean, resistant to UV rays and weathering.



# CRAZY HEAD



Design by Isabella Lovero + Enrico Bosa







Crazy Head appendiabiti multifunzionale  
Crazy Head multi-functional hanger-hook



### Crazy Head

Un portacasco da parete con un vano svuota tasche e un gancio appendiabiti. Crazy Head, disegnato da CrousCalogero per MY YOUR, è il complemento d'arredo perfetto per gli amanti della moto. La sua multifunzionalità e il suo design amichevolmente antropomorfo gli conferiscono una totale unicità per il suo settore di riferimento. Realizzato in Poleasy®, disponibile in versione gofrata stampata si può collocare sia in spazi indoor che outdoor che necessitano di una forte personalità.

A wall holder with a compartment empty pockets and a hanger hook. Crazy Head, designed by CrousCalogero for MY YOUR, is the perfect piece of furniture for bykers. Its multifunctionality and friendly anthropomorphic design give it a total uniqueness for its reference area. Made of Poleasy®, available in embossed printed version can be placed both indoors and outdoors that need a strong personality.





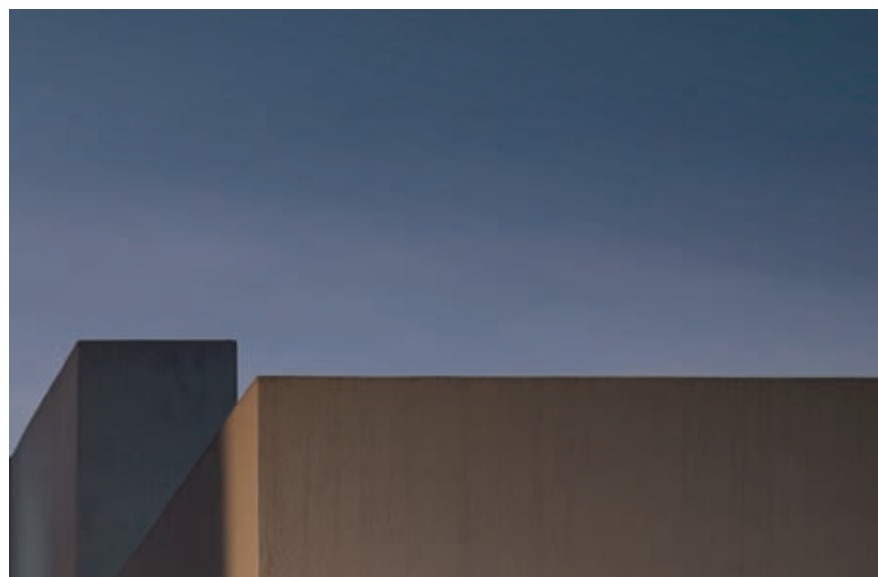

	Lampade da terra Standing lamps	Sospensioni Pendant lamps	Lampade galleggianti Floating lamps
	272 JOY	306 PANDORA LIGHTS	302, 304 PANDORA LIGHTS
	282 HOLLYWOOD	342 BABYLOVE	340 BABYLOVE
	290 PENELOPE	344 NEFOS	
	298, 308 PANDORA LIGHTS		Lampade da tavolo Table lamps
	312 AGATA		330 AMPOULE
	318 AGATA WOOD		350 LIGHT TALES
	324 AMPOULE		
	332 TULIP		
	338 BABYLOVE		



# JOY



Design by Lanzavecchia+Way







Joy lampada da giardino  
Joy garden lamp



## Joy

JOY è una lampada da terra in grande formato, disegnata da Lanzavecchia-Wai, che coniuga la base in marmo con i paralumi in Poleasy® attraverso lo stelo in metallo con finitura rame. Joy si ispira dichiaratamente all'atto di infilare le perle in una collana, le cui organiche superfici, realizzate grazie a strumenti di modellazione digitale ed esaltate dal materiale plastico, si fermano sul filo. Questo suggestivo e poetico concept outdoor, unitamente alla linearità del design, consente a Joy di adattarsi a molteplici contesti in cui esserne il gioiello.

JOY is a large size floor lamp, designed by Lanzavecchia-Wai, which combines the marble base with the Poleasy® lampshades through a copper finish metal stem. Joy is inspired by the act of putting the beads in a necklace, whose organic surfaces, made thanks to digital modelling tools and enhanced by the plastic material, stop on the wire. This striking and poetic outdoor concept, together with its design linearity allows Joy to adapt to multiple contexts in which to be a jewel.







Joy lampada da terra con base in marmo, tavolo tondo e poltroncine da pranzo Push - catalogo Extraordinary  
Joy standing lamp with marble base, Push round table and dining armchairs \_ Extraordinary catalog





Joy lampada da terra con base in ferro, Joy lampada da giardino, Joy lampada da terra con base in marmo  
Joy standing lamp with iron base, Joy garden lamp, Joy standing lamp with marble base



# HOLLYWOOD



Design by Brogliato Traverso







## Hollywood

Lampada dal design iconico e riconoscibile, Hollywood caratterizza ogni ambiente grazie al suo suggestivo impatto scenico. La possibilità di regolarne l'intensità luminosa e l'orientabilità del corpo illuminante la rende una trasversale e adattabile a multipli contesti: un'area lounge, l'ingresso di un locale o una zona living sia indoor che outdoor. La lampada Hollywood, disegnata da Brogliato Traverso, con il suo mood "fashion-industrial", rievoca un set cinematografico nel quale essere protagonista.

Lamp with an iconic and recognizable design, Hollywood characterizes every space thanks to its striking scenic impact. The ability to adjust the light intensity and the orientability of the lighting body makes it transversal and adaptable to multiple contexts: a lounge area, a club entrance or a living area both indoors and outdoors. The Hollywood lamp, designed by Brogliato Traverso, with its "fashion-industrial" mood, evokes a film set in which feeling like a star.





Hollywood lampada da terra  
Hollywood standing lamp





# PENELOPE

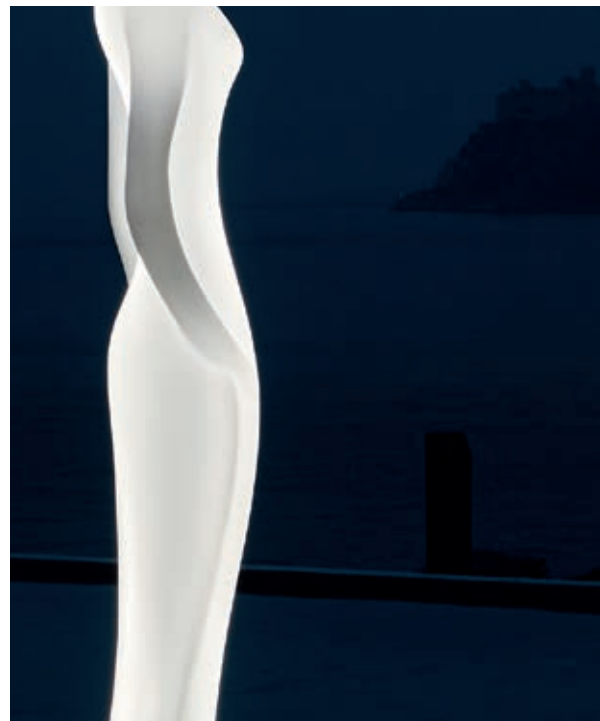

Design by More Design



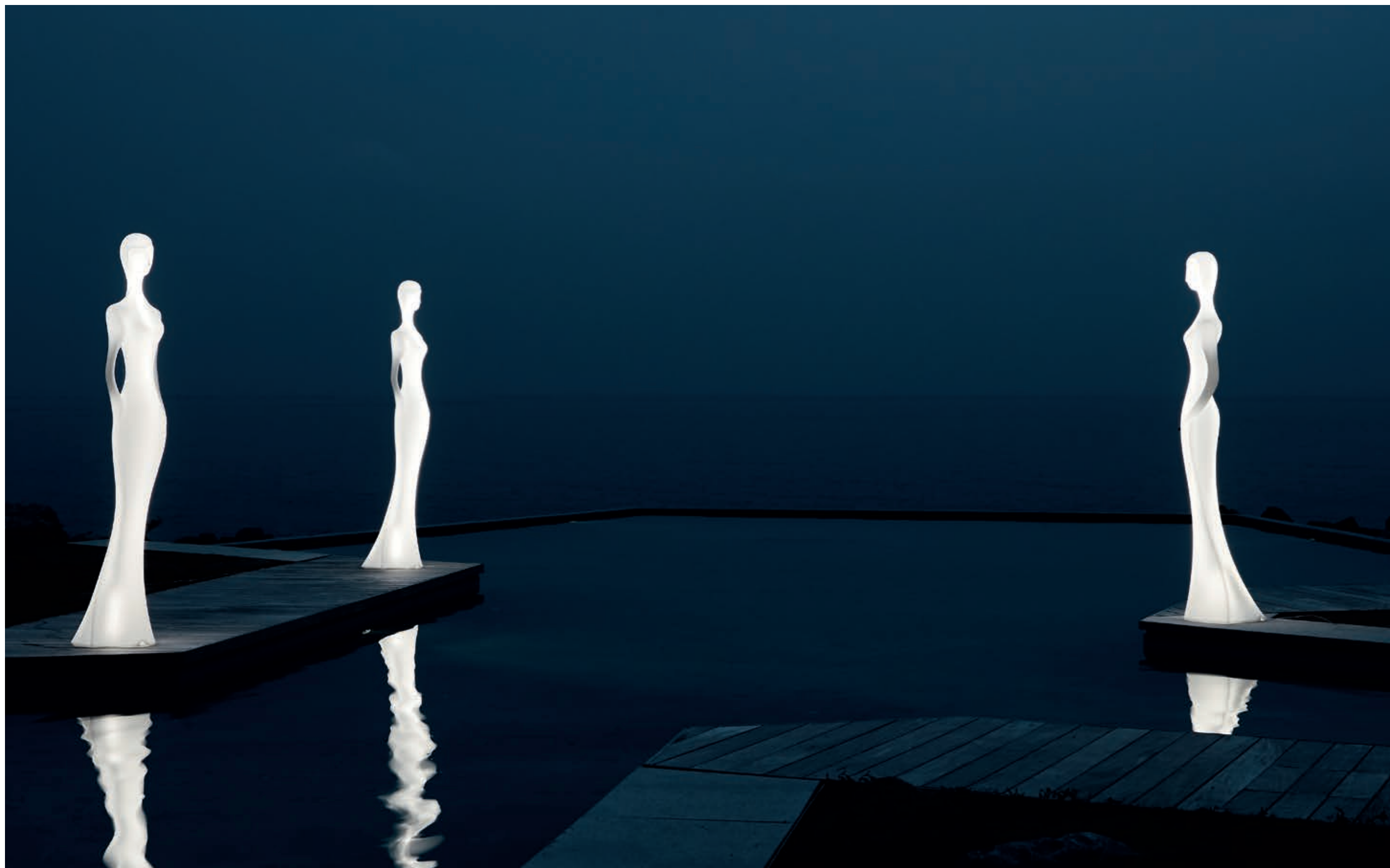

Penelope lampada da terra  
Penelope standing lamp





### Penelope

Ispirata alla scultura greca classica, è una combinazione di design, tecnologia e caratteristiche funzionali avanguardistiche. Con i suoi 210 cm di altezza, Penelope è fatta per stupire: come lampada illumina qualsiasi spazio con la sua bellezza classica, come scultura, in finitura ossidata, decora con eleganza suggestiva ciò che la circonda. Disegnata da More Design per MY YOUR, Penelope è uno dei prodotti icona di MY YOUR sin dalla sua prima produzione.

Inspired by classical Greek sculpture, it is a combination of design, technology and avant-garde functional features. With its 210 cm high, Penelope is made to amaze: as a lamp illuminates any space with its classic beauty, As a sculpture, in oxidized finishing, it decorates with evocative elegance what surrounds it. Designed by More Design for MY YOUR, Penelope has been one of MY YOUR's iconic products since its first production.





Penelope lampada da terra, Nefos L lampada sospensione  
 Penelope standing lamp, Nefos L pendant lamp



# PANDORA LIGHTS



Design by Brogliato Traverso



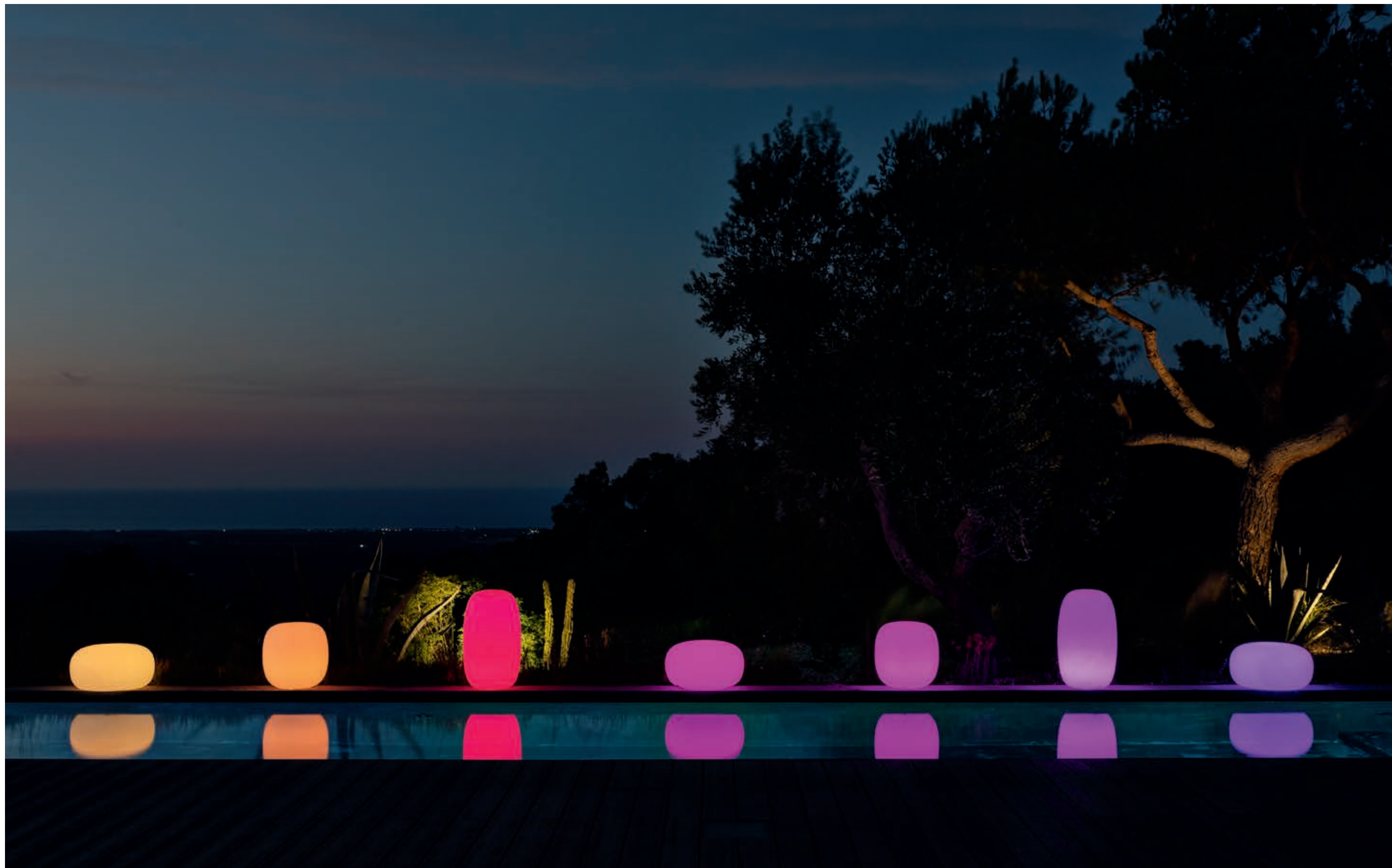

Pandora lampade da terra S, M, L  
Pandora S, M, L floor lamps



### Pandora Lights

La collezione Pandora, di Brogliato Traverso per MY YOUR, si completa con le lampade da terra, da soffitto e galleggianti. Le piantane a stelo centrale differiscono per paralume che ha lo stesso design delle sedute S, M e L mentre il modello XL si evolve in una forma ovoidale allungata. Si aggiunge alle lampade senza stelo, infine, il tavolino in versione luminosa anche galleggiante.

Minimali e arricchite dal pattern distintivo di tutta la collezione, disponibili in luce bianca LED e, dove consentito, in luce RGBW a batteria, le lampade Pandora decorano lo spazio con un'eleganza senza tempo.

The Pandora collection, by Brogliato Traverso for MY YOUR, is completed with floor, ceiling and floating lamps. The central stem stands differ for lampshade that has the same design as the S, M and L seats while the XL model evolves into an elongated ovoid shape. In addition to the lamps without stem, finally, the coffee table in a luminous and floating version.

Minimal and enriched by the distinctive pattern of the entire collection, available in white LED light and, where allowed, in battery-powered RGBW light, Pandora lamps decorate the space with a timeless elegance.







Pandora tavolino galleggiante waterproof  
Pandora floating waterproof coffee table









Pandora lampade da terra con stelo in metallo S, M e L  
Pandora S, M and L metal stem standing lamps





Pandora XL lampada da terra con stelo in metallo  
Pandora XL standing lamp with metal stem



# AGATA



Design by More Design







Agata lampada da terra  
Agata standing lamp



### Agata

Agata è una lampada da terra a stelo centrale in grande formato che si ispira dichiaratamente al design classico. La sua contemporaneità si attribuisce al materiale plastico in cui è realizzata e alla progettualità che ha alleggerito le forme smorzandole. La sua duttilità visiva e la sua costruzione tecnologica consentono un perfetto adattamento a qualsiasi ambiente outdoor, tuttavia, la sua eleganza stilistica viene spesso utilizzata anche per la progettazione di interni e l'allestimento di eventi o showroom.

Agata is a floor lamp with a central stem in large format that is openly inspired by the classic design. Its modernity is due to the plastic material in which it's made and to its softened shapes design. Its visual ductility and technological construction allow a perfect adaptation to any outdoor space, however, its stylistic elegance is also appreciated for interiors projects and events or showrooms setting up.





# AGATA WOOD



Design by More Design





Agata Wood lampada da terra  
Agata Wood standing lamp





### Agata Wood

Agata Wood è l'evoluzione di Agata in stile Anni Cinquanta, il cui supporto centrale a treppiede, in legno trattato per esterni, è tipico del design di quell'epoca. Realizzata con la moderna tecnologia rotazionale del diffusore in Poleasy®, Agata Wood si adatta ambivalentemente sia per progetti indoor che outdoor. Di facile manutenzione e pulizia, è testata per i raggi UV e per resistere agli agenti atmosferici.

Agata Wood is the Fifties style Agata evolution, whose central tripod support, in treated wood for outdoor use, was typical for that era. Made with the Poleasy® modern rotational technology diffuser, Agata Wood is ambivalently suitable for both indoor and outdoor projects. Easy to maintain and clean, it's tested for UV rays and weather resistance.



# AMPOULE



Design by Brogliato Traverso





Agata Wood lampada da terra  
Agata Wood standing lamp



## Ampoule

Una goccia di luce. Questo il pensiero ispiratore di Ampoule disegnata da Brogliato Traverso per MY YOUR. Esile e imponente, minimale e decorativa Ampoule è un ossimoro stesso nella sua essenza. Nella versione da terra oversize illumina grandi spazi outdoor, mentre, nella versione da tavolo accende la magia di una serata conviviale. Realizzati in Poleasy®, al 100% riciclabili, entrambi i modelli sono disponibili con sorgente luminosa RGBW o a luce bianca LED e con alimentazione a cavo o a batteria. Ampoule conferisce stile a ogni ambiente in cui si trova.

A drop of light. This is the inspiring thought of Ampoule designed by Brogliato Traverso for MY YOUR. Thin and imposing, minimal and decorative Ampoule is an oxymoron in its inner essence. In the oversize floor version it illuminates large outdoor spaces, while in the table version it turns on the magic of a convivial evening. Made of 100% recyclable Poleasy®, both models are available with RGBW or LED white light source and with cable or battery power. Ampoule gives style to any space in which it is located.







Ampoule lampada da tavolo  
Ampoule table lamp



# TULIP

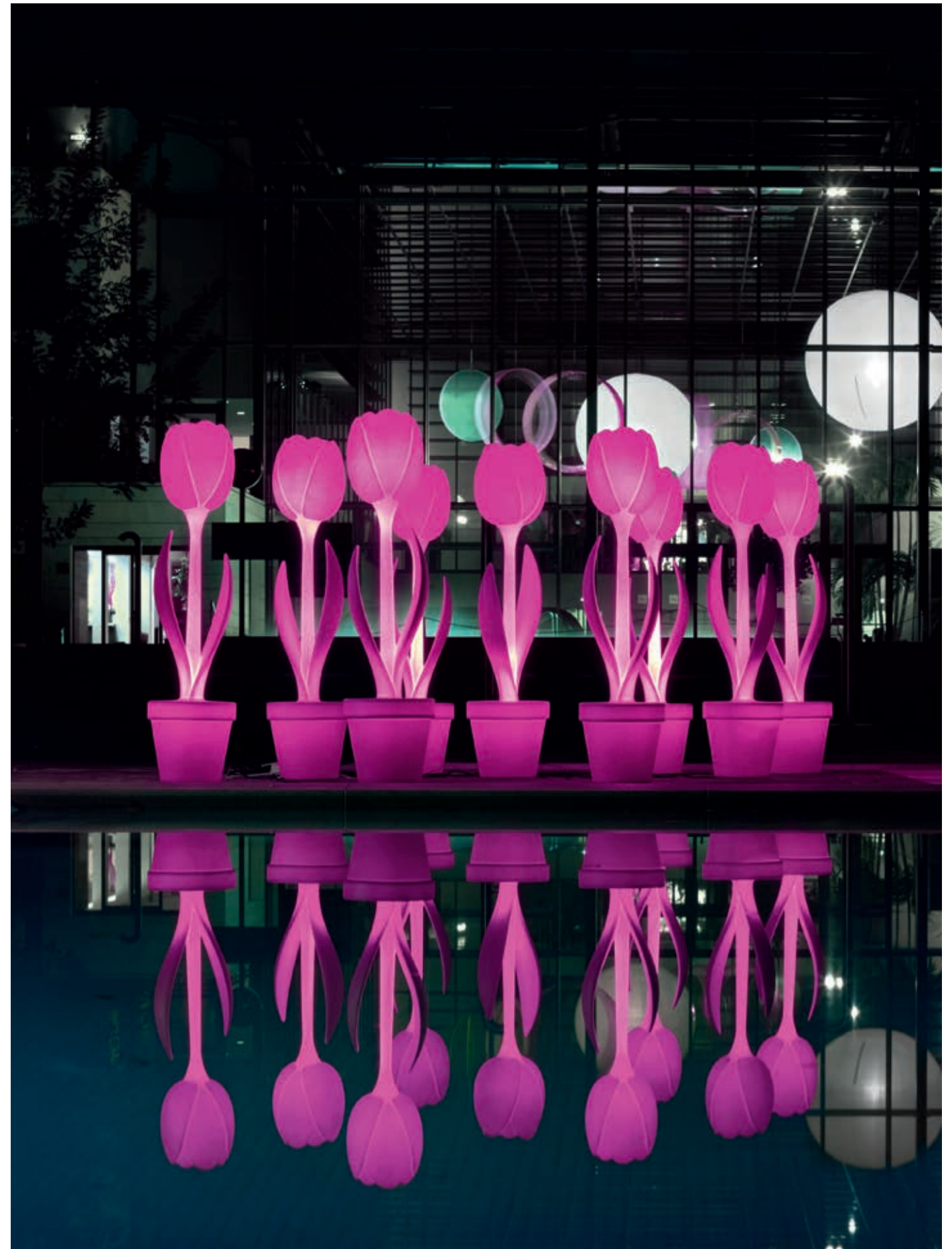

Design by More Design





Tulip lampada da terra  
Tulip standing lamp





## Tulip

MY YOUR edita la lampada Tulip, su disegno di More Design, nei primi anni di attività. Da allora, questa lampada-scultura dal design pop è divenuta un'icona riconoscibile per l'azienda stessa. Realizzata in Poleasy®, viene utilizzata sia per indoor che outdoor e vanta locations prestigiose e inaspettate. Aeroporti, trasmissioni televisive, grandi eventi sono state colorate dalle nuances della luce RGBW e dalle forme di Tulip in tutto il mondo. Un successo senza tempo, tutto in un fiore.

MY YOUR creates the Tulip lamp, designed by More Design, in the first years of its operation. Since then, this sculpture-lamp with a pop design has become a recognizable icon for the company itself. Made of Poleasy®, it's used both indoors and outdoors and boasts prestigious and unexpected locations. Airports, TV broadcasts, prestigious events have been colored by its RGBW light nuances and shapes around the world. A timeless success, all in one flower.



# BABYLOVE

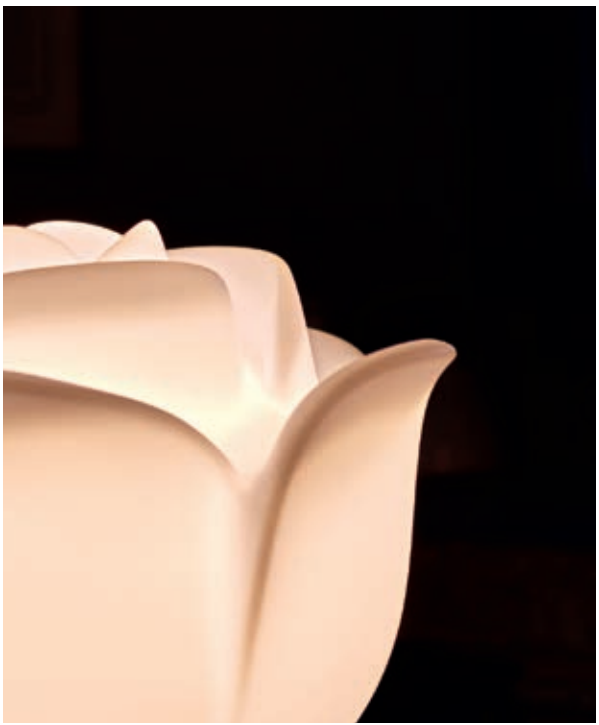

Design by MY YOUR R&D





Babylove lampade galleggianti waterproof  
Babylove floating waterproof lamps





### Babylove

Lampada ornamentale dallo stilizzato design a forma di rosa, Baby Love può assumere diverse forme: piantana in due altezze, sospensione per outdoor e lampada galleggiante waterproof con fonte luminosa RGBW e alimentazione a batteria. Dichiaratamente pop, Baby Love è perfetta per ambienti dal target giovanile, per locali e hotel alla moda e per scenografie dal forte impatto visivo. Realizzata con stelo in alluminio e con paraluce in Poleasy®, è una risposta poetica e suggestiva alle moderne esigenze di luce decorativa.

Ornamental lamp with a stylized rose flower design, Baby Love can take different forms: floor lamp in two heights, suspension for outdoors and waterproof floating lamp with RGB light source and with power battery supply. Admittedly pop, Baby Love is perfect for young target spaces, for trendy clubs and hotels and for sceneries with a strong visual impact. Made by a aluminum stem and with lampshade made of Poleasy®, it's a poetic and evocative response to the modern needs of decorative light.



# NEFOS

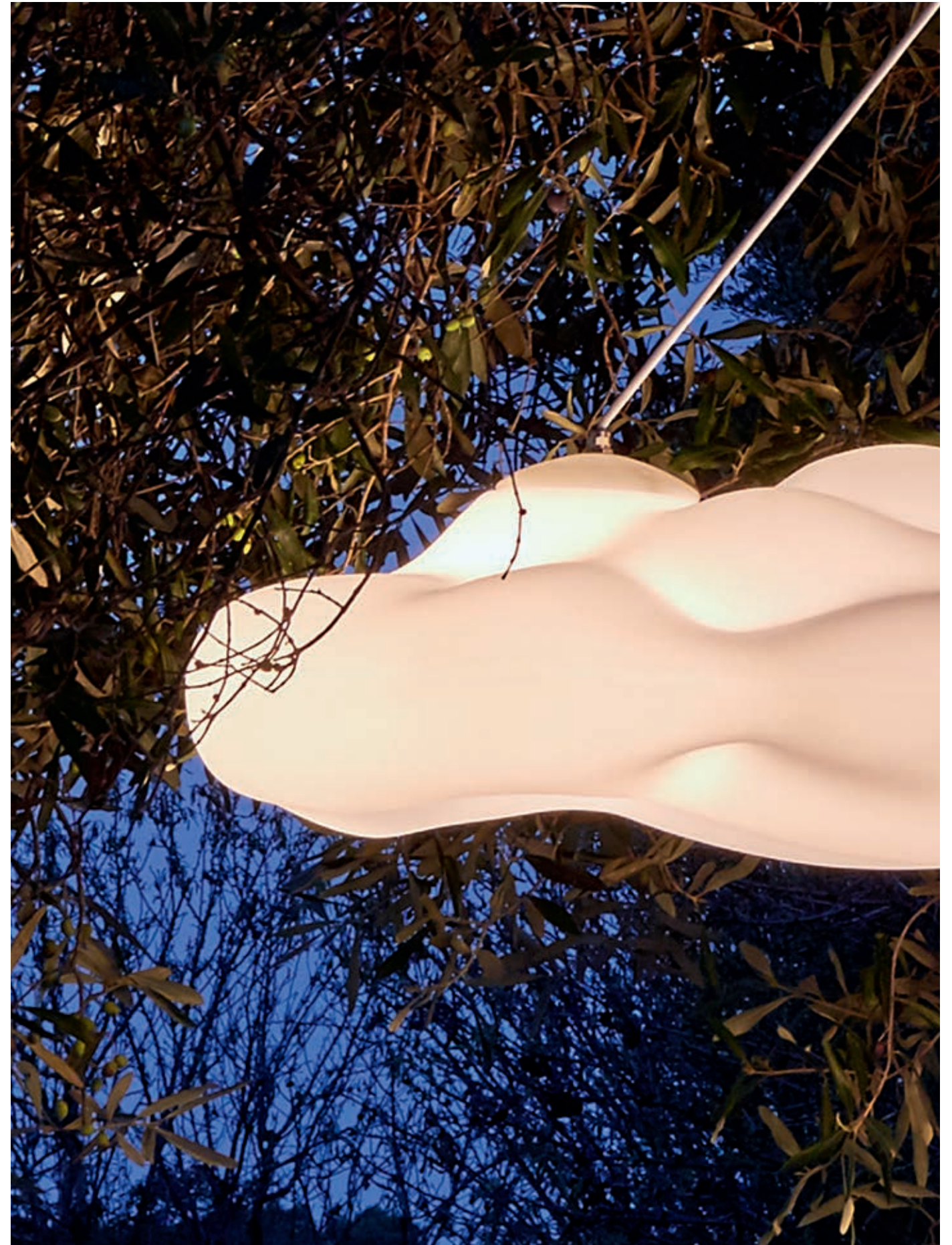

Design by Paolo De Lucchi









### Nefos

Nefos significa "nuvola" in greco. L'Architetto Paolo De Lucchi ha creato per MY YOUR una lampada a sospensione, a luce diffusa, ispirandosi proprio a questo design. Oniricamente suggestiva e quasi felliniana, Nefos illumina tutti gli spazi sia indoor che outdoor che necessitano di un sogno stilistico.

Realizzata in Poleasy®, Nefos è dotata di indice di protezione contro gli agenti atmosferici, si pulisce facilmente ed è testata contro le incurie del tempo e i raggi UV.

Nefos means "cloud" in Greek. Architect Paolo De Lucchi created a pendant lamp for MY YOUR, with diffused light, inspired by this design. Dreamily suggestive and almost Fellinian, Nefos illuminates both indoor and outdoor spaces that need a stylish dream.

Made of Poleasy®, Nefos is equipped with a protection index against atmospheric agents. It's easy to clean and tested for weathering and UV rays.



# LIGHT TALES



Design by Ale Giorgini + Brogliato Traverso







Mobi XL lampada da terra  
Mobi XL floor lamp



## Light Tales

Dall'idea di Ale Giorgini e dallo sviluppo progettuale di Brogliato Traverso nasce la collezione di lampade da tavolo Light Tales che rappresenta, letteralmente, nel modello Moby "Pinocchio", nel modello Cat "Alice nel paese delle meraviglie", nel modello Tin "Il Mago di Oz", nel modello Rose "La Bella e la Bestia" e nel modello Tri "I tre piccoli porcellini". Moby viene subito esposto in Triennale di Milano per la mostra "Pinocchio" nel 2017 e vince il Good Design Award nello stesso anno. Questa collezione accende la fantasia quando si illumina, ed è perfetta per chiunque voglia sognare e tornare bambino, senza limiti di età.

From an Ale Giorgini idea and a Brogliato Traverso design development here the Light Tales lamps collection which represents, literally, "Pinocchio" in the Moby model, "Alice in Wonderland" in the Cat model, "The Wizard of Oz" in the Tin model, "The Beauty and the Beast" in the Rose model, "The three little pigs" in Tri model. Moby has been exhibited at the Milan Triennale's "Pinocchio" exhibition in 2017 and won the Good Design Award in the same year. This collection turns on the imagination when it lights up, and it's perfect for anyone who wish to dream and become a child again, without age limits.







Light Tales in versione spenta e accesa  
Light Tales off-on light versions





Tri lampada da tavolo  
Tri table lamp







Divani e poltrone  
Sofas and armchairs

362 SAMURAI

370 2054

376 CHICO

380 NOVA

386 LILY

392 MODI`

Sedute e tavoli  
Seats and table

396 COMMUNITY SET

400 MISS PETRA

402 MR LEM

404 BART

406 PANDORA

412 OXFORD

414 LIBERTY

Banconi  
Counters

418 NOVA BANCONE  
+ DUBLIN

428 BARAONDA

Coperture  
Sun covers

434 KITE



Separatori  
Dividers

- 438 FLAMINGO  
442 NONVASO  
446 FRAMES  
448 BA\_GIGIO

Vasi per esterno  
Outdoor pots

- 462 GEM  
406, 408 PANDORA POTS  
468 SKIN  
474 TAO

Complementi  
Accessories

- 478 TINO  
482 CRAZY HEAD

Lettini  
Sunbeds

- 452 CLOE  
454 ZOE  
384 NOVA LETTINO  
456 BALI

Docce  
Showers

- 460 DYNO







## Samurai

Samurai è una collezione di sedute modulari outdoor dalle linee pulite ed essenziali ed è caratterizzata da una seduta ampia e bassa che ne implementa la leggerezza visiva. I braccioli e gli schienali, dalle forme contenute e aperte, accolgono i cuscini di seduta, aumentandone il comfort mentre i piedini sollevano e sostengono la struttura. Samurai si presenta in due versioni: Samurai Baseline con imbottitura in poliuretano e tessuto Sunbrella®, e Samurai Plusline con imbottitura in poliuretano, Dryfeel®, tessuto drenante Sunbrella®.

Samurai is a modular outdoor collection with clean and essential lines and is characterized by a wide and low seat that implements the visual lightness. The armrests and backrests, with small and slightly open shapes, welcome the seat cushions, increasing their comfort while the feet lift and support the structure. Samurai comes in two versions: Samurai Baseline with polyurethane padding and Sunbrella® fabric, and Samurai Plusline with polyurethane padding, Dryfeel®, Sunbrella® draining fabric.

### Poltrona e pouf Armchair and pouf

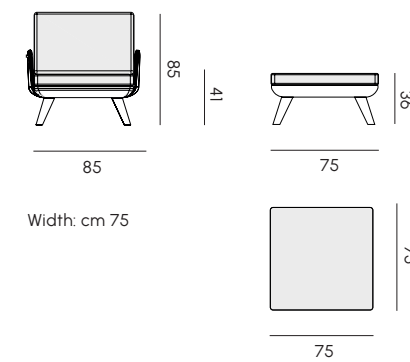

### Divano 2 posti 2 seats sofa

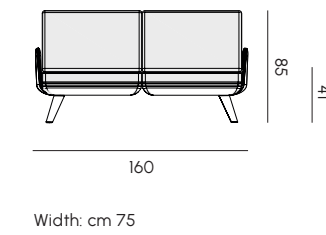

### Divano 3 posti 3 seats sofa

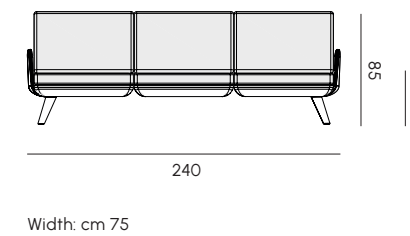

### Divano 4 posti 4 seats sofa

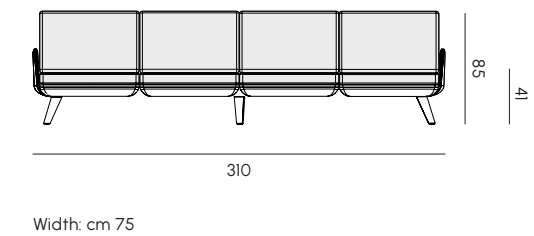

### Divano 4 posti con tavolo 4 seats sofa with table

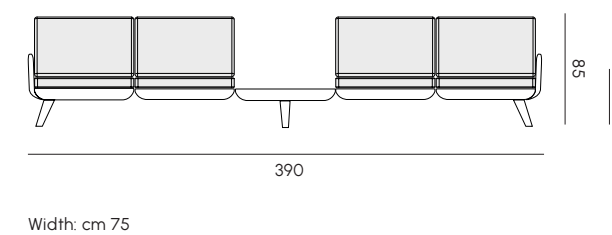



**Divano 5 posti**  
5 seats sofa

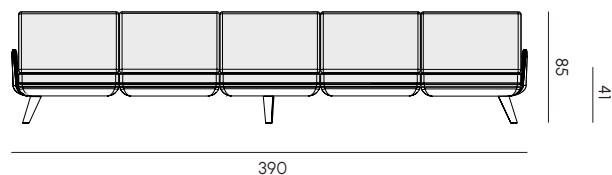

Width: cm 75

**Composizione angolare a 3 posti**  
3 seats corner set

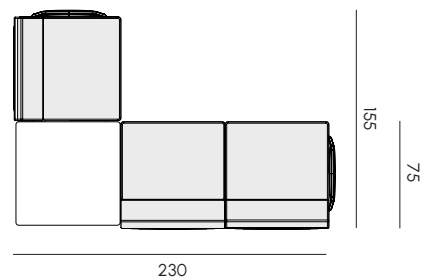

Height: cm 85 / 41 seat

**Composizione angolare a 4 posti**  
4 seats corner set

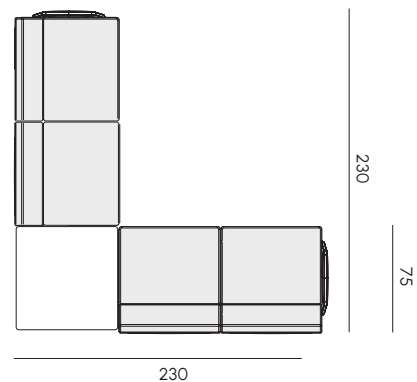

Height: cm 85 / 41 seat

**Composizione angolare a 5 posti**  
5 seats corner set

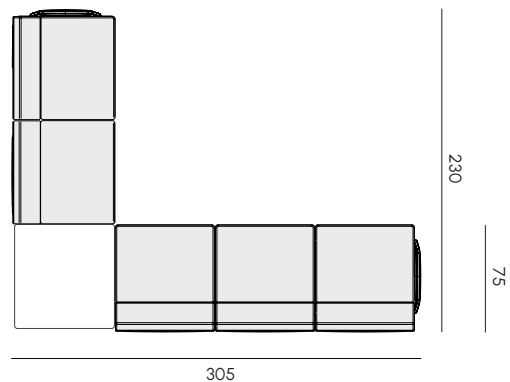





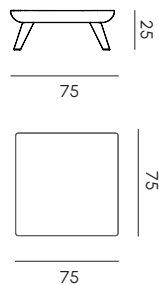





Height: cm 85 / 41 seat

**Tavolino**  
Coffee table

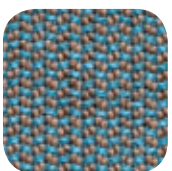
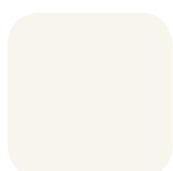

**Abbinamenti per divani e poltrone Samurai Plusline**  
Combinations for sofas and armchairs

Structure Poleasy®	Structure Poleasy®	Tessuto Fabric
 white 117	 beige 212	 melange white 02
 white 117	 beige 212	 melange gray 63
 white 117	 beige 212	 melange light blue 242
 white 117		 melange green 7623

Le immagini dei materiali e dei colori sono indicative, in quanto possono subire lievi variazioni in stampa.  
The materials and colors images serve as a mere indication, as they can vary slightly when printed.



### Abbinamenti per divani e poltrone Samurai Baseline

Combinations for sofas and armchairs

#### Finishing

GS

#### Tessuto

Fabric



white  
117



beige  
212



ice  
3966 solid



white  
117



beige  
212

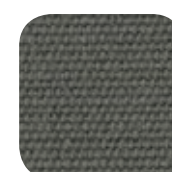

gray  
3737 solid

Struttura sedute	Poleasy®	Frame	Poleasy®
Aggancio scocca	Alluminio	Shell anchoring	Aluminium
Imbottitura Baseline	Poliuretano sagomato	Baseline upholstery	Shaped polyurethane
Imbottitura Plusline	Dryfeel®	Plusline upholstery	Dryfeel®
Rivestimento Baseline	Tessuto idrorepellente per esterni	Baseline cover	Outdoor water-repellent fabric
Rivestimento Plusline	Tessuto drenante per esterni	Plusline cover	Outdoor draining fabric
Piedini	Anima di alluminio rivestita in plastica	Feet	Plastic coated aluminium core
Telo a copertura impermeabile	Poliestere con superficie resinata	Waterproof cove cloth	Polyester with external resin surface

Le immagini dei materiali e dei colori sono indicative, in quanto possono subire lievi variazioni in stampa.  
The materials and colors images serve as a mere indication, as they can vary slightly when printed.





**Poltrona imbottita con braccioli\***  
Upholstered armchair with armrests

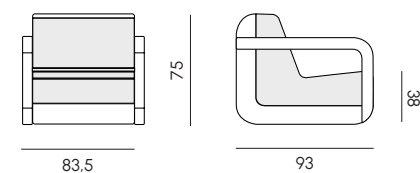

**Seduta imbottita\***  
Upholstered seat

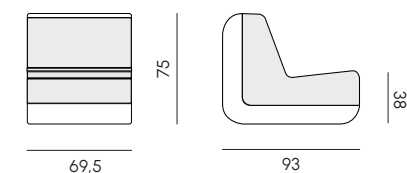

**Seduta imbottita con braccioli\***  
Upholstered seat with armrests

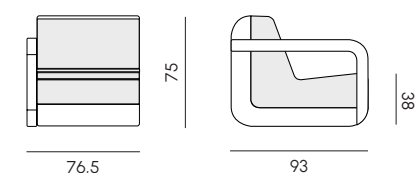

**Tavolino**  
Coffee table

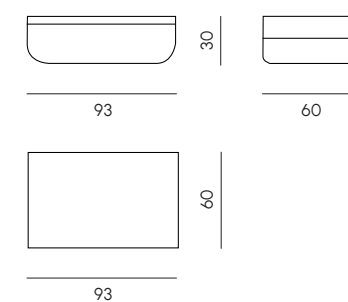

## 2054

2054, disegnata da Valerio Cometti per MY YOUR, è una collezione di divani, poltrona e tavolino in moduli componibili per progettare e vivere il proprio outdoor living. È realizzata in Poleasy® e imbottiti per esterno. I suoi punti di forza sono la componibilità, la qualità dei materiali, tutti riciclabili, e il comfort avvolgente delle sedute. Disponibile nella versione in finta pelle bianca per esterni, è facile manutenzione e pulizia ed è testato per resistere nel tempo agli agenti atmosferici.

2054, designed by Valerio Cometti for MY YOUR, is a sofas, armchair and coffee table collection in modular elements to design and live your outdoor living. It is made of Poleasy® and upholstered for outdoor use. Its strong points are the modularity, the quality of the materials, all recyclable, and the enveloping comfort of the seats. Available in the version in white faux leather for outdoors, it's easy maintenance and cleaning and it's tested to withstand the weather.

\* L'imbottitura è in poliuretano sagomato con membrana idrofilica e rivestimento in finta pelle per esterni  
The upholstery is made by shaped polyurethane with hydrophilic membrane, covered by outdoor imitation leather



### Seduta monoblocco

Monoblock seat

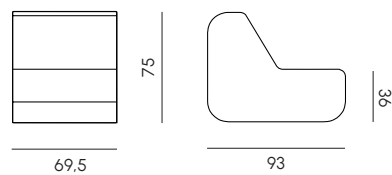

### Seduta monoblocco con braccioli

Monoblock seat with armrests

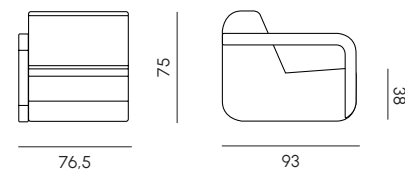

### Poltrona monoblocco con braccioli

Basic armchair with armrests

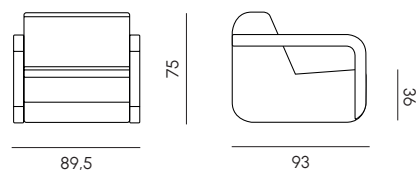

### Abbinamenti per divani e poltrone

Combinations for sofas and armchairs

#### Finishing

GS

#### Tessuto

Eco-leather

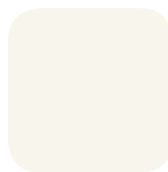

white  
117



white  
6

\*Tutta la struttura è in Poleasy®  
All the structure is made by Poleasy®

Struttura	Poleasy®	Frame	Poleasy®
Imbottitura	Poliuretano sagomato (dove previsto)	Upholstery	Shaped polyurethane
Membrana idrofilica	Tessuto impermeabile e traspirante (dove previsto)	Hydrophilic membrane	Waterproof and breathable fabric
Rivestimento	Finta pelle per esterni	Cover	Outdoor imitation leather
Telo di copertura impermeabile	Poliestere con superficie resinata	Waterproof cove cloth	Polyester with external resin surface

Le immagini dei materiali e dei colori sono indicative, in quanto possono subire lievi variazioni in stampa.  
The materials and colors images serve as a mere indication, as they can vary slightly when printed.



### Tavolino luminoso

Light coffee table

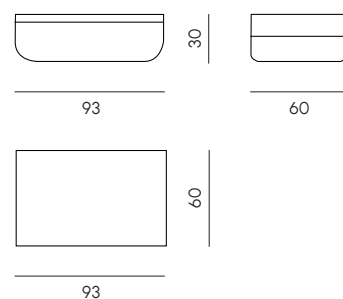

### Colori disponibili

Available colors

### Finishing

IL

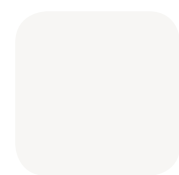

translucent  
110

Struttura	Poleasy®	Frame	Poleasy®
Fonte luminosa	LED RGBW 3.8W	Light source	LED RGBW 3.8W
Potenza assorbita	Adattatore: AC: 100-240V 50/60Hz DC: 7.5V	Power Input	Adaptor: AC: 100-240V 50/60Hz DC: 7.5V
Metodo di ricarica	Induzione elettrica al litio	Recharging method	Lithium electric induction
Tempo di ricarica	4-5 h	Recharging time	4-5 h
Durata di carica	8-10 h	Duration time	8-10 h
Indice di protezione lampada	IP66	Lamp protection index	IP66
Indice di protezione cavo di ricarica	IP20	Recharging cable protection index	IP20
Lunghezza cavo	1,5 m	Recharging cable length	1,5 m
Switch	Telecomando	Switch	Remote control

Le immagini dei materiali e dei colori sono indicative, in quanto possono subire lievi variazioni in stampa.  
The materials and colors images serve as a mere indication, as they can vary slightly when printed.



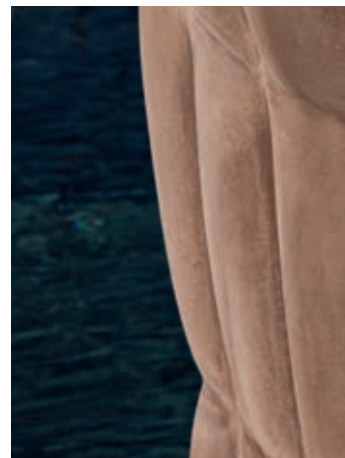

Struttura	Poleasy®	Frame	Poleasy®
Imbottitura cuscini	Poliuretano sagomato	Cushions upholstery	Shaped polyurethane
Rivestimento cuscini	Tessuto idrorepellente per esterni	Cushions cover	Outdoor water-repellent fabric

#### Poltrona Armchair

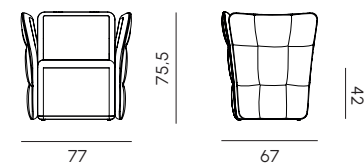

#### Cuscino poltrona Armchair cushion

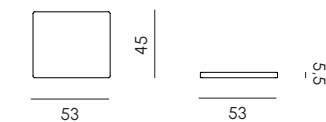

#### Divano 2 posti 2 seats sofa

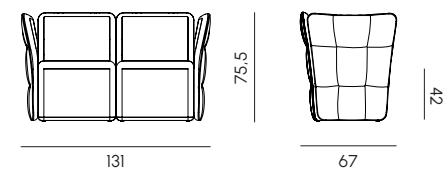

#### Cuscino divano 2 posti 2 seats sofa cushion

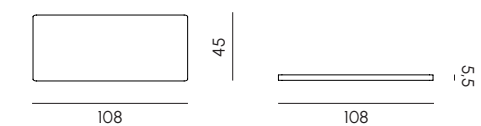

#### Chico

Chico è un sistema modulare di sedute outdoor ideato da More Design per MY YOUR che si decanta in modulo centrale, moduli laterali e poltrona. Interamente in Poleasy®, il suo decoro distintivo ricorda la trapuntatura del capitonnè, e le sue forme slanciate gli consentono di arredare spazi anche contenuti.

Pensato per ambienti outdoor Chico strizza l'occholino all'interior design nella nuova finitura Velvet, che lo avvolge morbidamente in una veste alto borghese. Disponibile con scuscino di seduta, è testato, in ogni finitura, per resistere agli agenti atmosferici nel tempo ed è facilmente lavabile.

Chico is a modular system of outdoor seats designed by More Design for MY YOUR that consists of central module, side modules and armchair. Entirely in Poleasy®, its distinctive decoration recalls capitonnè process, and its slender shapes allow it to furnish even contained spaces.

Designed for outdoors, Chico winks at the interior design in the new Velvet finish, which envelops it softly in a high middle-class look. Available with seat cushion, it's tested in every finish to withstand the weather and it's easily washable.

#### Divano 3 posti 3 seats sofa

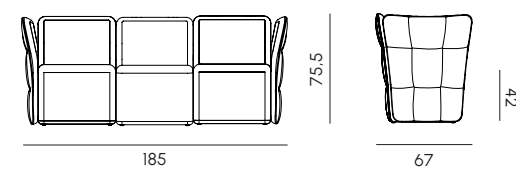

#### Cuscino divano 3 posti 3 seats sofa cushion

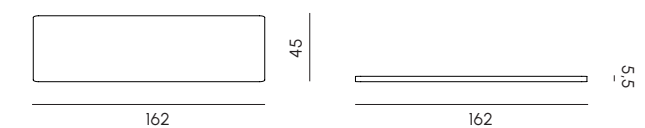



Abbinamenti per divani e poltrone  
Combinations for sofas and armchairs

Finishing  
GS

Tessuto  
Fabric



white  
117



melange white  
02

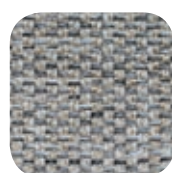

melange gray  
63



melange light blue  
242



beige  
212



melange white  
02

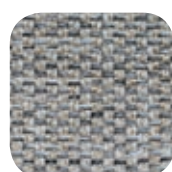

melange gray  
63



melange light blue  
242



gray  
87



melange white  
02



melange gray  
63



melange light blue  
242

Abbinamenti per divani e poltrone  
Combinations for sofas and armchairs

Finishing  
VL

Tessuto  
Fabric



velvet beige  
804



melange white  
02

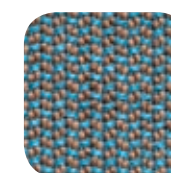

melange light blue  
242

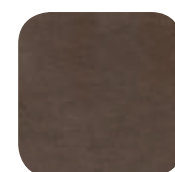

velvet brown  
92



melange white  
02

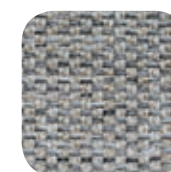

melange gray  
63



velvet green\*  
208



melange white  
02

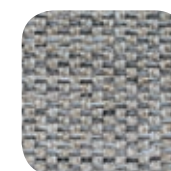

melange gray  
63



velvet blue\*  
840



melange white  
02



melange gray  
63

\* Per le finiture Velvet green e Velvet Blue la quantità minima ordinabile è di 6 pezzi  
For Velvet Green and Velvet Blue finishes the minimum order quantity is 6 pieces

Le immagini dei materiali e dei colori sono indicative, in quanto possono subire lievi variazioni in stampa.  
The materials and colors images serve as a mere indication, as they can vary slightly when printed.





## Nova

Nova è una collezione di divani in due altezze, poltrona, panca e lettino, disegnata da Brogliato Traverso per MY YOUR. Presenta a complemento i cuscini in materiali idrorepellenti e si abbina al tavolino 2054 nelle composizioni lounge.

Grazie al suo design minimal ed elegante, garantisce un comfort avvolgente e una versatilità verso ogni tipo di outdoor in cui essere inserita. Testata per l'esterno, è di facile pulizia e manutenzione.

Nova is a collection of sofas in two heights, armchair, bench and sunbed, designed by Brogliato Traverso for MY YOUR. It complements the cushions in water repellent materials and matches the 2054 coffee table in the lounge compositions.

Thanks to its minimal and elegant design, it guarantees an enveloping comfort and a versatility towards any type of outdoor in which to be inserted. Tested for weathering, it is easy to clean and maintain.

### Poltrona Armchair

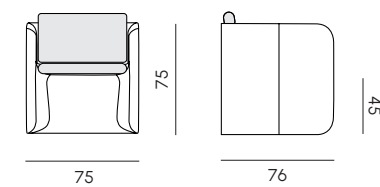

### Divano S Sofa S

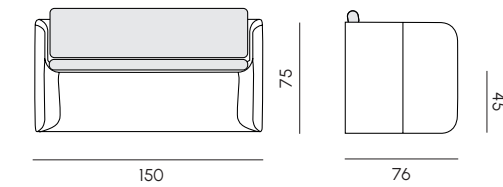

### Divano XL Sofa XL

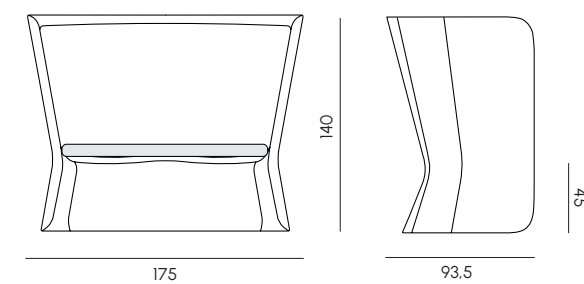

### Panca Bench

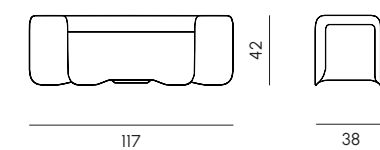

### Tavolino 2054\* Coffee table

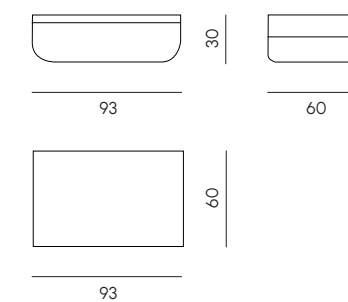

\* Il tavolino 2054 è disponibile anche nella versione luminosa. Fonti luminose: RGBW con cavo di ricarica.  
The 2054 coffee table is also available in the light version. Light sources: RGBW with recharging cable.













**Abbinamenti per divani, poltrone e tavolino 2054 in finitura Velvet**  
 Velvet finishes combinations for sofas, armchairs and 2054 coffee table

Finishing VL	Tessuto Fabric	
		
velvet beige 804	melange white 02	melange light blue 242
		
velvet brown 92	melange white 02	melange gray 63
		
velvet green* 208	melange white 02	melange gray 63
		
velvet blue* 840	melange white 02	melange gray 63

\* Per le finiture Velvet green e Velvet Blue la quantità minima ordinabile è di 6 pezzi  
 For Velvet Green and Velvet Blue finishes the minimum order quantity is 6 pieces

Struttura	Poleasy®	Frame	Poleasy®
Rivestimento cuscini	Tessuto idrorepellente per esterni	Cushions cover	Outdoor water-repellent fabric
Imbottitura cuscini	Poliuretano sagomato	Cushions upholstery	Shaped polyurethane

**Abbinamenti per divani e poltrone e tavolino 2054**  
 Combinations for sofas and armchairs and 2054 coffee table

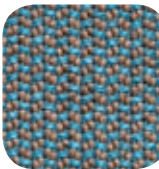
Finishing GS			Tessuto Fabric
			
white 117	beige 212	gray 87	melange white 02
			
white 117	beige 212	gray 87	melange gray 63
			
white 117	beige 212	gray 87	melange light blue 242

Le immagini dei materiali e dei colori sono indicative, in quanto possono subire lievi variazioni in stampa.  
 The materials and colors images serve as a mere indication, as they can vary slightly when printed.



### Lettino Sunbed

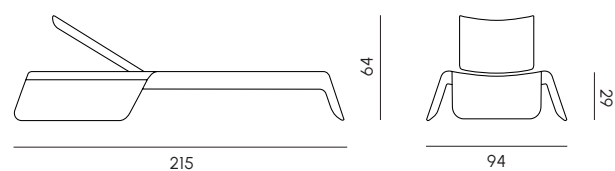

### Materassino Mattress

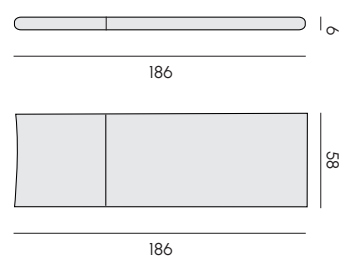

### Abbinamenti per lettini Combinations for sunbeds

### Finishing GS

white  
117

ice  
3966 solid

Struttura	Poleasy®	Frame	Poleasy®
Rivestimento materassino	Tessuto idrorepellente per esterni	Mattress cover	Outdoor water-repellent fabric
Imbottitura materassino	Poliuretano sagomato	Mattress upholstery	Shaped polyurethane
Ruote	Materiale plastico	Wheels	Plastic material

Le immagini dei materiali e dei colori sono indicative, in quanto possono subire lievi variazioni in stampa.  
The materials and colors images serve as a mere indication, as they can vary slightly when printed.



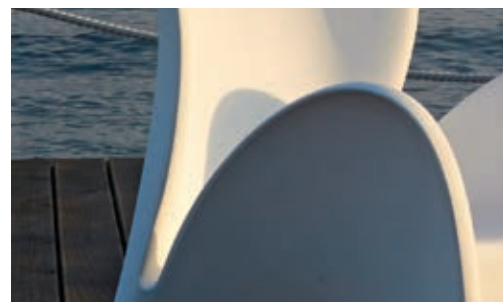

**Sedia**  
Chair

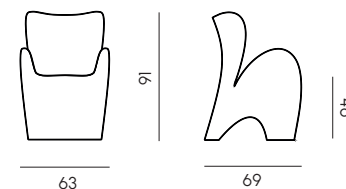

**Cuscino sedia**  
Chair cushion

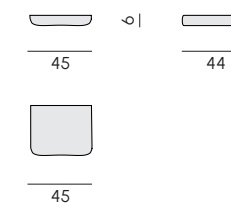

**Poltrona**  
Armchair

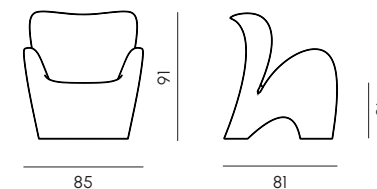

**Cuscino poltrona**  
Armchair cushion

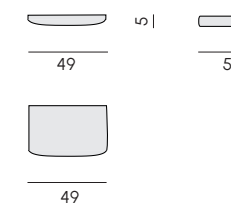

**Divano**  
Sofa

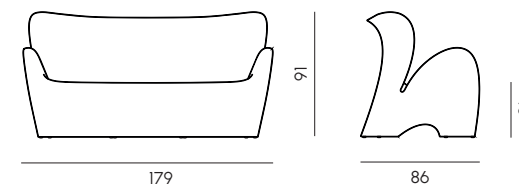

**Cuscino divano**  
Sofa cushion

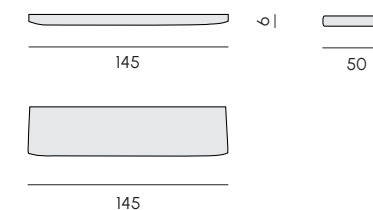

## Lily

La collezione Lily di More Design per MY YOUR si decanta in divano, poltrona, tavolino, anche in versione luminosa, e tavolino con ice box. A complemento cuscini di seduta e spumantiera.

Lily è una delle collezioni icona di MY YOUR e il suo successo è dovuto alle forme organiche, avvolgenti e sinuose che ricordano i petali di un fiore. Grazie al Poleasy® con cui è realizzata, resiste agli agenti atmosferici e si pulisce facilmente. Lily dona carattere a ogni ambiente in cui si trova.

The Lily collection by More Design for MY YOUR is composed by sofa, armchair, coffee table, also in luminous version, and coffee table with ice box. To complement seat cushions and icebox.

Lily is one of the MY YOUR iconic collections and its success is due to the organic, enveloping shapes and sinuous reminiscent of a flower petal. Thanks to the Poleasy®, with which it is made, it resists atmospheric agents and is easily cleaned. Lily gives character to any space it is in.



### Tavolino Coffee table

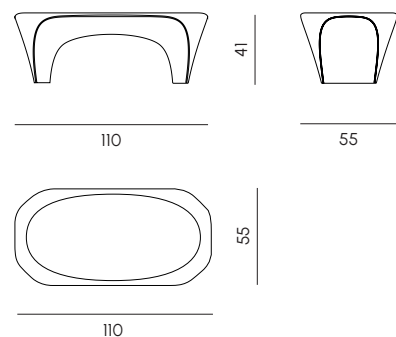

### Tavolino con ice box Ice-box coffee table

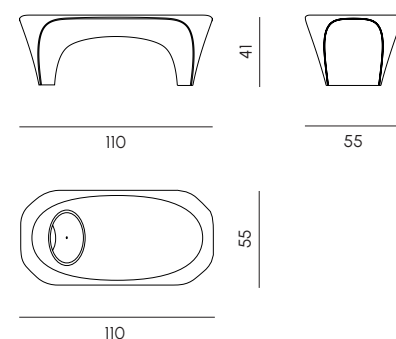

### Spumantiera Ice-box

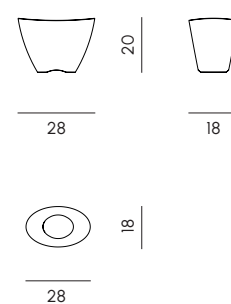

Struttura	Poleasy®	Frame	Poleasy®
Imbottitura cuscini	Poliuretano sagomato	Cushions upholstery	Shaped polyurethane
Rivestimento cuscini	Tessuto idrorepellente per esterni	Cushions cover	Outdoor water-repellent fabric

### Abbinamenti per divano, poltrona, sedia e colori tavolino\* Combinations for sofa, armchair, chair e colori tavolino

#### Finishing GS

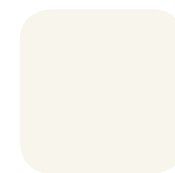

white  
117

#### Finishing VL

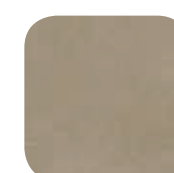

velvet beige  
804



velvet green  
208

#### Tessuto Fabric



ice  
3966 solid



gray  
87



velvet brown  
92

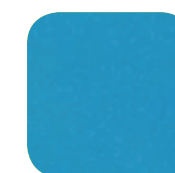

velvet blue  
840



ice  
3966 solid

\* Per le finiture Velvet green e Velvet Blue la quantità minima ordinabile è di 6 pezzi  
For Velvet Green and Velvet Blue finishes the minimum order quantity is 6 pieces

Le immagini dei materiali e dei colori sono indicative, in quanto possono subire lievi variazioni in stampa.  
The materials and colors images serve as a mere indication, as they can vary slightly when printed.



### Tavolino luminoso Light coffee table

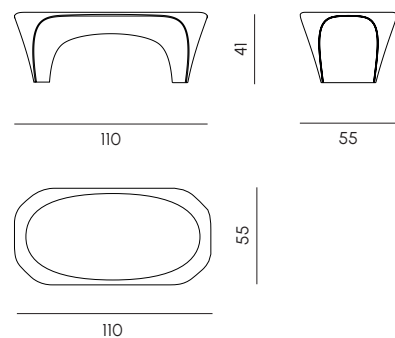

### Tavolino luminoso con ice-box Light ice-box coffee table

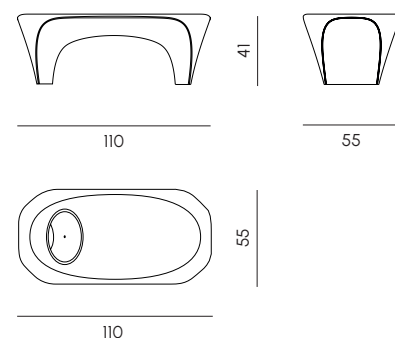

Struttura	Poleasy®	Frame	Poleasy®
Fonte luminosa	LED RGBW 3.8W	Light source	LED RGBW 3.8W
Potenza assorbita	Adattatore: AC: 100-240V 50/60Hz DC: 7.5V	Power Input	Adaptor: AC: 100-240V 50/60Hz DC: 7.5V
Metodo di ricarica	Induzione elettrica al litio	Recharging method	Lithium electric induction
Tempo di ricarica	4-5 h	Recharging time	4-5 h
Durata di carica	8-10 h	Duration time	8-10 h
Indice di protezione lampada	IP66	Lamp protection index	IP66
Indice di protezione cavo di ricarica	IP20	Recharging cable protection index	IP20
Lunghezza cavo	1,5 m	Recharging cable length	1,5 m
Switch	Telecomando	Switch	Remote control

### Colori disponibili per tavolino Coffee table available colors

#### Finishing IL

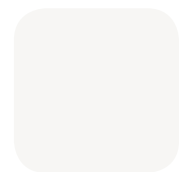

translucent  
110

Le immagini dei materiali e dei colori sono indicative, in quanto possono subire lievi variazioni in stampa.  
The materials and colors images serve as a mere indication, as they can vary slightly when printed.



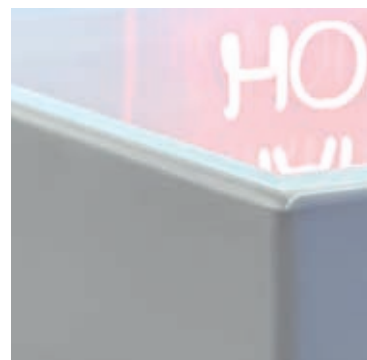

## Modi

Modi è una collezione disegnata da More Design per MY YOUR che nasce dall'ambiziosa idea di creare un unico modulo adattabile a tutte le sedute. Allo stesso modo anche la ricerca dei materiali si coniuga all'esigenza di costruire una morbidezza componibile. La seduta, infatti, è costituita da singoli moduli imbottiti e rivestiti, che si incastrano uno a uno nella base e compongono un decoro che richiama le trapuntature classiche quiltate. Disponibile in ecopelle per esterni e realizzato con struttura in Poleasy®, si completa con il tavolino con piano in vetro. Modi può essere composto con versatilità in qualsiasi spazio esterno.

Modi is a collection designed by More Design for MY YOUR that comes from the ambitious idea of creating a single module adaptable to all seats. In this way, the search for materialism also combines the need to build a modular softness. The seat, in fact, consists of individual upholstered modules, which fit one by one into the base and make up a decoration that recalls the classic quilting. Available in eco-leather for outdoors and with structure in Poleasy®, it's completed by the coffee table with glass top. Modi can be assembled with versatility in any outdoor space.

### Poltrona e pouf Armchair and pouf

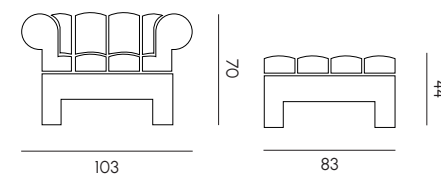

Width: cm 62

### Modulo sinistro con bracciolo Left module with armrest

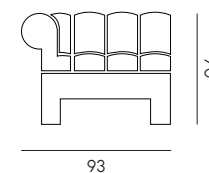

Width: cm 62

### Modulo centrale Core module

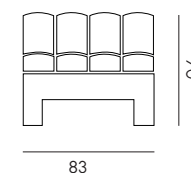

Width: cm 62

### Divano Sofa

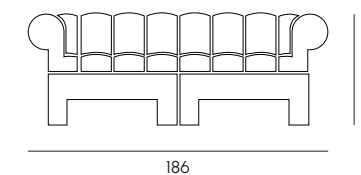

Width: cm 62

### Modulo destro con bracciolo Right module with armrest

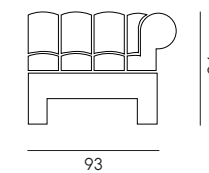

Width: cm 62

### Tavolino con piano in vetro Coffee table with glass top

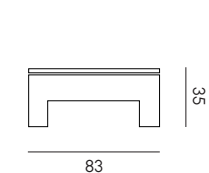

Width: cm 62



### Modulo base Basement

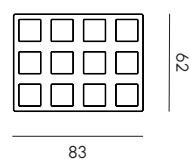
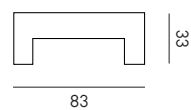

### Moduli imbottiti Upholstered modules

bracciolo  
armrest

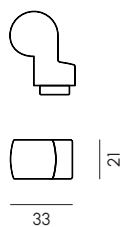

angolo  
corner

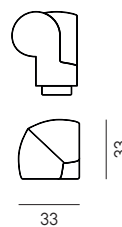

elemento centrale  
central element

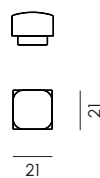

### Accorgimenti \* Precautions



\*\* Modi non è adatto per gli agenti atmosferici diretti  
Modi is not suitable for direct weathering

### Piano in vetro per tavolino \*\* Coffee table glass top

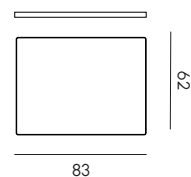

\*\* Vetro extrachiaro acidato temperato  
Extraclear frosted tempered glass

### Componibilità \*\*\* Modularity

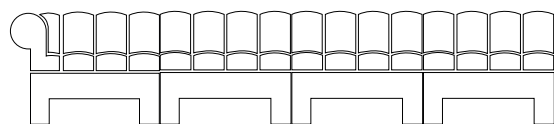

\*\*\* Modi è componibile all'infinito  
Modi is freely assembled

Struttura	Poleasy®	Frame	Poleasy®
Imbottitura	Poliuretano sagomato	Upholstery	Shaped polyurethane
Rivestimento	Finta pelle per esterni	Cover	Outdoor imitation leather
Telo a copertura impermeabile	Poliestere con superficie resinata	Waterproof cove cloth	Polyester with external resin surface

### Abbinamenti suggeriti Suggested combinations

Finishing  
GS

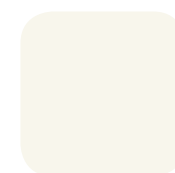

white  
117



black  
210

Tessuto  
Eco-leather



white  
6



white  
6

Piano in vetro \*  
Glass top

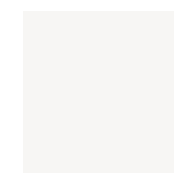

white  
BI

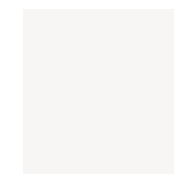

white  
BI

\* Vetro extrachiaro acidato temperato  
Extraclear frosted tempered glass

Le immagini dei materiali e dei colori sono indicative, in quanto possono subire lievi variazioni in stampa.  
The materials and colors images serve as a mere indication, as they can vary slightly when printed.



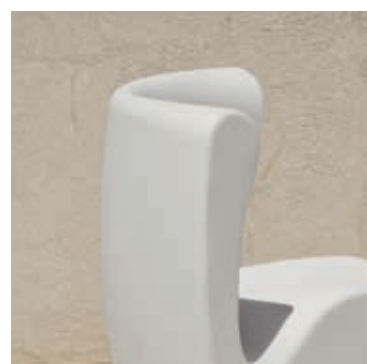

### Community set

Le suggestioni di un unico corpo scultoreo che si apre divenendo funzionale e definito. Questo il pensiero dietro a Community set ideato da More Design. Un incastro perfetto fra le sedie Rhonda e il tavolo Teddy consentono a questa collezione, interamente in Poleasy®, di essere versatile e adatta anche ad ambienti contenuti. Le linee curve e avvolgenti del design coniugano estetica e sicurezza. Disponibile sia in finitura goffrata stampata, sia in versione luminosa con sorgente RGB e batteria a induzione (per il tavolo Teddy) è testato per gli agenti atmosferici ed è di facile manutenzione e pulizia.

The suggestions of a single sculptural body that opens becoming functional and defined. This is the thought behind Community set created by More Design. A perfect joint between the Rhonda chairs and the Teddy table allow this collection, entirely in Poleasy®, to be versatile and also suitable for small spaces. The design curved and enveloping lines combine aesthetics and safety. Available in printed embossed finish, as well as in luminous version with RGB source and induction battery (Teddy table only) it is tested for weathering and is easy to maintain and clean.

Struttura Poleasy®

Frame Poleasy®

### Community set Community set

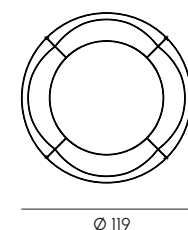
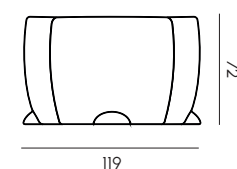

### Tavolo Teddy e poltroncina da pranzo Rhonda Teddy table and Rhonda dining armchair

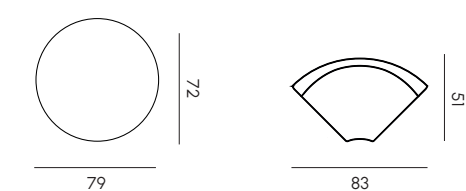
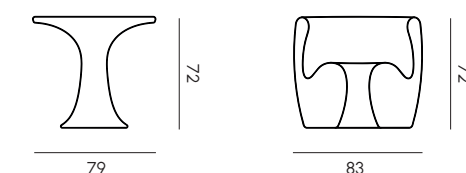

### Colori disponibili Available colors

### Finishing GS

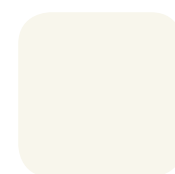

white  
117

**Le immagini dei materiali e dei colori sono indicative, in quanto possono subire lievi variazioni in stampa.**  
The materials and colors images serve as a mere indication, as they can vary slightly when printed.



### Tavolo Teddy luminoso

Light Teddy table

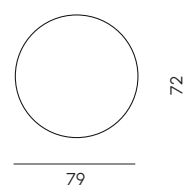
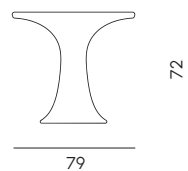

### Colori disponibili

Available colors

### Finishing\*

IL

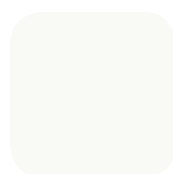

translucent  
110

Struttura	Poleasy®	Frame	Poleasy®
Fonte luminosa	LED RGBW 3.8W	Light source	LED RGBW 3.8W
Potenza assorbita	Adattatore: AC: 100-240V 50/60Hz DC: 7.5V	Power Input	Adaptor: AC: 100-240V 50/60Hz DC: 7.5V
Metodo di ricarica	Induzione elettrica al litio	Recharging method	Lithium electric induction
Tempo di ricarica	4-5 h	Recharging time	4-5 h
Durata di carica	8-10 h	Duration time	8-10 h
Indice di protezione lampada	IP66	Lamp protection index	IP66
Indice di protezione cavo di ricarica	IP20	Recharging cable protection index	IP20
Lunghezza cavo	1,5 m	Recharging cable length	1,5 m
Switch	Telecomando	Switch	Remote control

Le immagini dei materiali e dei colori sono indicative, in quanto possono subire lievi variazioni in stampa.  
The materials and colors images serve as a mere indication, as they can vary slightly when printed.



Struttura

Poleasy®

Frame

Poleasy®

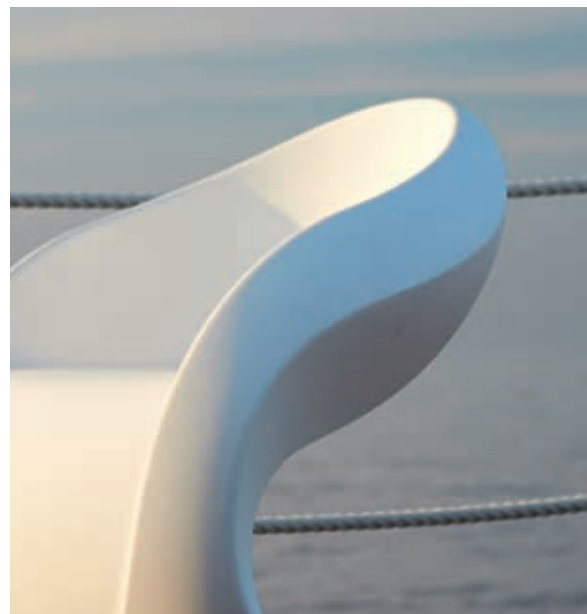

### Poltrona Armchair

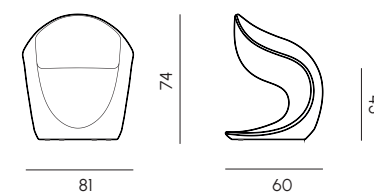

### Colori disponibili Available colors

### Finishing GS

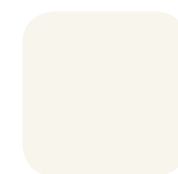
white  
117

### Miss Petra

Con la sua avvolgente rotondità, Miss Petra, disegnata da More Design per MY YOUR, sfida la gravità con una struttura potente, resistente e sicura grazie a un attento e avanguardistico sviluppo industriale. Una poltrona gioiello dalle forme sinuose e confortevoli. Interamente in Poleasy®, è ideale per spazi indoor e outdoor dalla forte personalità. Resiste agli agenti atmosferici, è di facile manutenzione e si pulisce facilmente.

With its enveloping roundness, Miss Petra, designed by More Design for MY YOUR, challenges gravity with a powerful, durable and safe structure thanks to a careful and avant-garde industrial development. A jewel armchair with sinuous and comfortable shapes. Entirely in Poleasy®, it is perfect for indoor and outdoor spaces with a strong personality. Weather resistant, easy to maintain and easy to clean.

**Le immagini dei materiali e dei colori sono indicative, in quanto possono subire lievi variazioni in stampa.**  
The materials and colors images serve as a mere indication, as they can vary slightly when printed.



Struttura

Poleasy®

Frame

Poleasy®



### Sgabello Stool

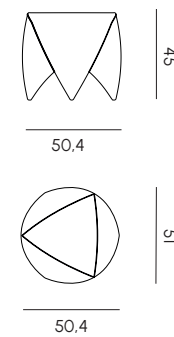

### Colori disponibili Available colors

### Finishing GS

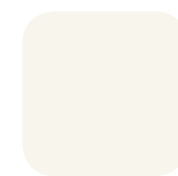
white  
117black  
210lilac  
404

### Mr Lem

Lo sgabello Mr Lem, disegnato da More Design, si ispira a una navicella spaziale e al primo sbarco sulla luna. Linee semplicemente distintive, progettualità efficace e pensata ad incastro per essere velocemente impilabile e per ottimizzare la volumetria nei trasporti. Realizzato in Poleasy® si adatta ad ambienti indoor e outdoor in cui sia necessario un tocco glamour e brioso. Testato per utilizzo in esterno, è di facile pulizia e manutenzione.

Mr Lem stool, designed by More Design, is inspired by a spaceship and the first landing on the moon. Simply distinctive lines, effective design and designed to fit together to be quickly stackable and to optimize the volume in transport. Made of Poleasy<sup>®</sup> it is suitable for indoor and outdoor environments where a touch of glamour and vivacity is needed. Tested for outdoor use, it is easy to start and maintenance.

**Le immagini dei materiali e dei colori sono indicative, in quanto possono subire lievi variazioni in stampa.**  
The materials and colors images serve as a mere indication, as they can vary slightly when printed.





Struttura

Poleasy®

Frame

Poleasy®

### Sgabello Stool

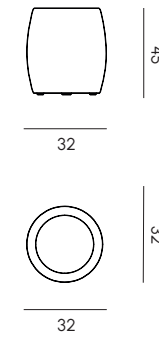

### Colori disponibili Available colors

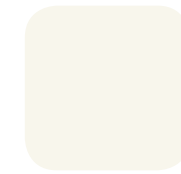
Finishing  
GSFinishing  
VLwhite  
117velvet beige  
804velvet brown  
92velvet green  
208velvet blue  
840

## Bart

Lo sgabello Bart, disegnato da More Design, è uno storico best-seller per MY YOUR per i prodotti gofrati stampati. Realizzato in Poleasy® si adatta a qualsiasi ambiente indoor e outdoor. Disponibile in bianco e nelle nuove finiture Velvet, è spesso abbinato al tavolo Teddy del Community set. Testato per la vita outdoor, Bart è la risposta leggera, veloce ed elegante alla progettazione di lounge, di eventi, di bar, di lidi attrezzati o, semplicemente, della terrazza della propria casa. Si pulisce e si mantiene facilmente.

The Bart stool, designed by More Design, is a MY YOUR historical best-seller for printed embossed products. Made of Poleasy® it adapts to any indoor and outdoor space. Available in white and in the new Velvet finishes, it is often combined with the Community set Teddy table. Tested for outdoor life, Bart is the light, fast and elegant answer to the lounges, events, bars, equipped beaches or, simply, the terrace of your own home design. It is easy to clean and maintain.

\* Per le finiture Velvet green e Velvet Blue la quantità minima ordinabile è di 6 pezzi  
For Velvet Green and Velvet Blue finishes the minimum order quantity is 6 pieces

Le immagini dei materiali e dei colori sono indicative, in quanto possono subire lievi variazioni in stampa.  
The materials and colors images serve as a mere indication, as they can vary slightly when printed.



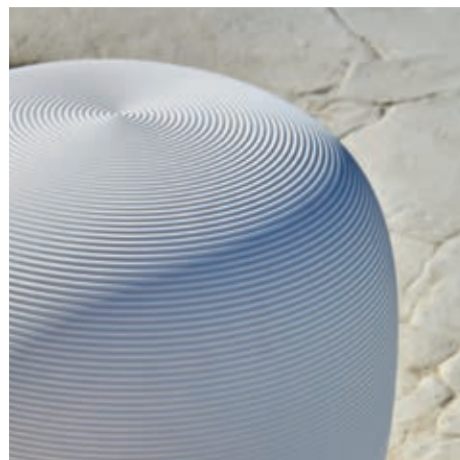

## Pandora

Lo collezione Pandora di More Design per MY YOUR è fra le più rappresentative e riconoscibili per i prodotti in materia plastica. Realizzato in Poleasy® si compone di pouf in tre modelli, tavolino, vasi in tre dimensioni, lampade sospensioni, lampade da terra in tre altezze, pouf e tavolini galleggianti luminosi. Una famiglia articolata, versatile e finemente decorata dal pattern concentrico che ne determina il carattere. Perfetta e testata per qualsiasi progetto outdoor, è di facile manutenzione e pulizia.

The Pandora collection by More Design for MY YOUR is among the most representative and recognizable for plastic products. Made in Poleasy®, it consists of poufs in three models, coffee table, vases in three sizes, suspension lamps, floor lamps in three heights, luminous poufs and floating tables. An articulated family, versatile and finely decorated by the concentric pattern that determines the character. Perfect and tested for any outdoor project, it is easy to maintain and clean.

Struttura Poleasy®

Frame Poleasy®

### Sgabello S Stool S

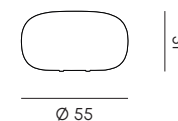

### Sgabello M Stool M

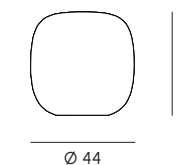

### Tavolino Coffee table

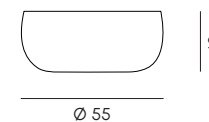

### Vaso S Pot S

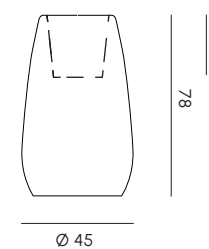

### Vaso M Pot M

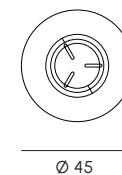
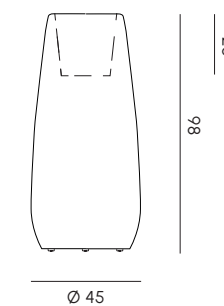

Ø 45

25

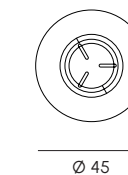

Ø 45

25



**Fioriera/ Ice-box**  
Planter/ Ice-box

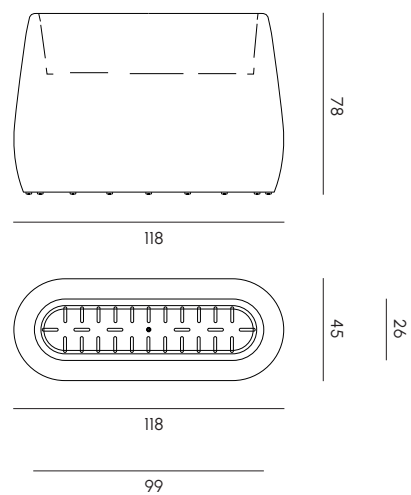

**Colori disponibili**  
Available colors

**Finishing**  
GS



white  
117

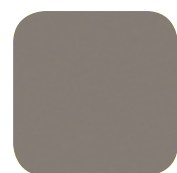

beige  
212



pearl gray  
180

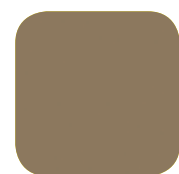

beige  
804



gray  
87



dark pearl  
162

**Finishing**  
OV

Le immagini dei materiali e dei colori sono indicative, in quanto possono subire lievi variazioni in stampa.  
The materials and colors images serve as a mere indication, as they can vary slightly when printed.





**Vaso S luminoso**  
Light Pot S

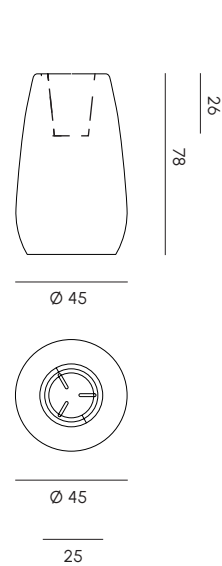

**Vaso M luminoso**  
Light Pot M

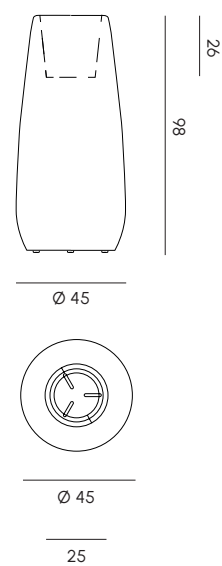

**Fioriera/ Ice box e Fioriera/ Ice box luminosa**  
Plant box/ Ice box and Plant box/ Ice box luminous

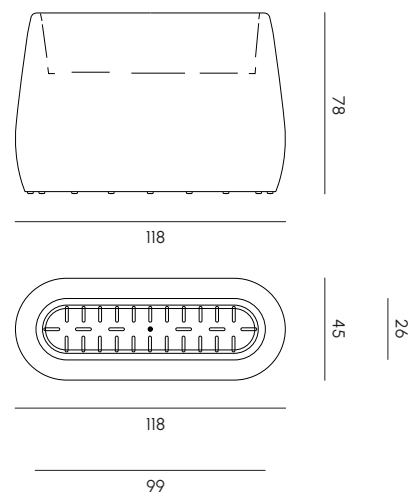

Diffusore	Poleasy®	Lampshade	Poleasy®
Fonte luminosa	N° 1 o 2 lampadine E27 LED (non fornite) max 20W - 230V 50/60Hz in base alla misura	Light source	N° 1-2 E27 LED bulbs (not included) max 20W - 230V 50/60Hz depending by the size
Alimentazione	110-240V 50/60Hz	Power supply	110-240V 50/60Hz
Indice di protezione cavo di ricarica	IP44	Recharging cable protection index	IP44
Lunghezza cavo	2 m con spina	Recharging cable length	2m with plug
Switch	Spina	Switch	Plug

**Colori disponibili**  
Available colors

**Finishing**  
IL

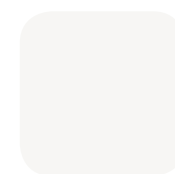

translucent  
110

Le immagini dei materiali e dei colori sono indicative, in quanto possono subire lievi variazioni in stampa.  
The materials and colors images serve as a mere indication, as they can vary slightly when printed.



Struttura

Poleasy®

Frame

Poleasy®

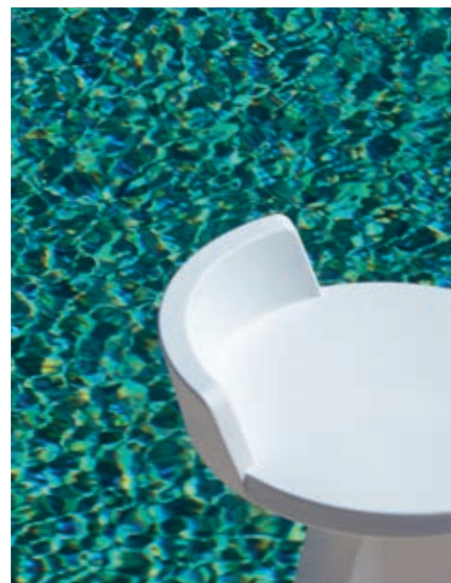
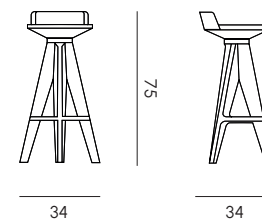
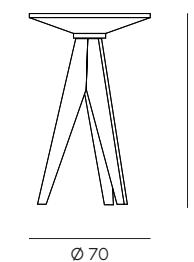
Sgabello  
StoolTavolo  
Table

## Oxford

Oxford è una collezione, disegnata da Brogliato Traverso per MY YOUR, composta da sgabello e tavolo alto, con piano in Poleasy®, dalle forme geometriche che dissimulano il materiale plastico ed emulano la forma iconica dello sgabello treppiede in legno. Lo smontaggio delle gambe assicura, inoltre, un contenuto volume di trasporto e stoccaggio. Entrambi i prodotti sono perfetti per il settore contract e hospitality. Testati per gli agenti atmosferici, si puliscono e si mantengono facilmente.

Oxford is a collection, designed by Brogliato Traverso for MY YOUR, that consists of stool and high table, with Poleasy® top, with geometric shapes that conceal the plastic material and emulate the iconic shape of the wooden tripod stool. The dismantling of the legs also ensures a transport and storage low volume. Both products are perfect for the contract and hospitality sector. Weatherproof, they are easy to clean and maintain.

Colori disponibili  
Available colors

Finishing  
GS

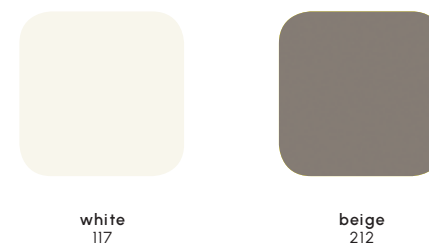

Le immagini dei materiali e dei colori sono indicative, in quanto possono subire lievi variazioni in stampa.  
The materials and colors images serve as a mere indication, as they can vary slightly when printed.





**Sgabello S**  
Stool S

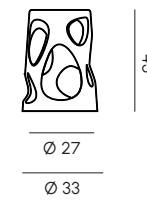

**Sgabello L**  
Stool L

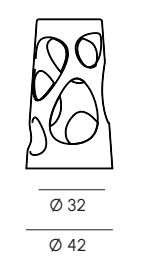

**Fusto tavolo XL**  
Table base XL

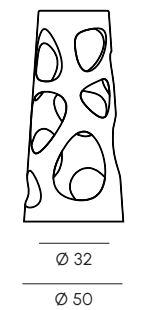

## Liberty

L'idea di Liberty si sviluppa da un gioco organico di vuoti e pieni. Le cavità della struttura esaltano la superficie bicolore e creano un pattern dinamico che muta con la rotazione del prodotto. La collezione Liberty, disegnata da More Design per MY YOUR, denota una forte connotazione pop attraverso il binomio cromatico dei materiali e un design decorativo-funzionale che ne evidenzia le caratteristiche. Ideali per il settore contract e perfettamente impilabili, resistono agli agenti atmosferici e sono facili da mantenere.

Liberty idea develops from an organic game of empty and full areas. The structure cavities enhance the two-tone surface and create a dynamic pattern that changes with the product rotation. The Liberty collection, designed by More Design for MY YOUR, denotes a strong pop connotation through the chromatic materials combination and a decorative-functional design that highlights its characteristics. Ideal for the contract sector and perfectly stackable, they resist weathering and are easy to maintain.

**Piano per tavolo Ø 70**  
Ø 70 table top

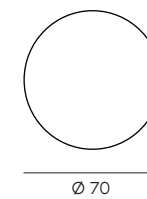

**Piano per tavolo Ø 90**  
Ø 90 table top

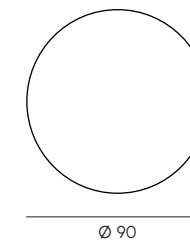



Struttura

Poleasy®

Frame

Poleasy®

### Colori disponibili

Available colors

### Finishing

GS

### Table tops

HPL

Outside

Inside

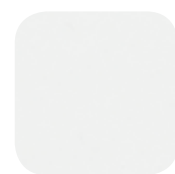
white  
117black  
210HPL  
white black core  
054

Le immagini dei materiali e dei colori sono indicative, in quanto possono subire lievi variazioni in stampa.  
The materials and colors images serve as a mere indication, as they can vary slightly when printed.







### Nova Bancone e Dublin Bancone

Nova Bancone è l'ultimo arrivato nella famiglia Nova disegnata da Brogliato Traverso per MY YOUR. Il design, rigoroso e ammorbidito dagli angoli leggermente smussati, consente una leggerezza formale che rende Nova Bancone versatile e adatto a qualsiasi ambiente.

Dublin Bancone si ispira nei dettagli ai pub irlandesi in stile Art Decò. I fianchi richiudibili per il modulo lineare, la possibilità di personalizzazione del fronte, i diversi tipi di illuminazione e la sua maneggevolezza fanno di Dublin uno strumento funzionale e decorativo per locali, hotel, ristoranti, bar ed eventi sia indoor che outdoor. Entrambi i prodotti sono accessoriabili su richiesta con cocktail station e speed rack in ABS.

Nova Bancone is the latest addition to the Nova family designed by Brogliato Traverso for MY YOUR. The design, rigorous and softened by the slightly rounded corners, allows a formal lightness that makes Nova Bancone versatile and suitable for any space.

Dublin Bar is inspired by the details of Irish Art Deco style pubs. The foldable sides for the linear module, the possibility of customization of the front, the different types of lighting and its handling make Dublin a functional and decorative tool for both indoor and outdoor venues, hotels, restaurants, bars and events. Both products can be equipped on demand with ABS cocktail station and speed rack.

### Nova modulo lineare Nova straight element

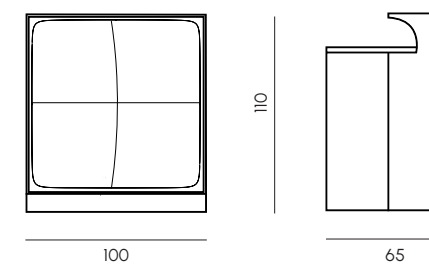

### Nova modulo angolare Nova corner element

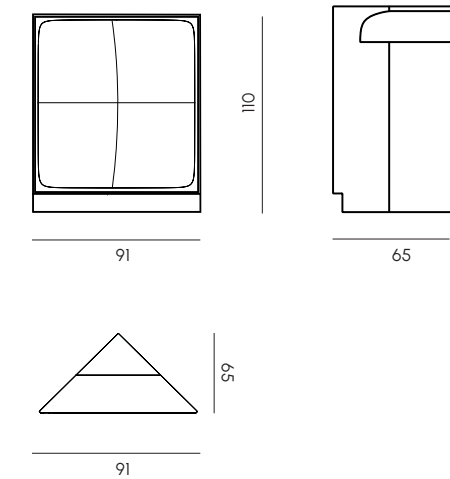

### Nova modulo lineare con cocktail station ABS Nova straight element with ABS cocktail station

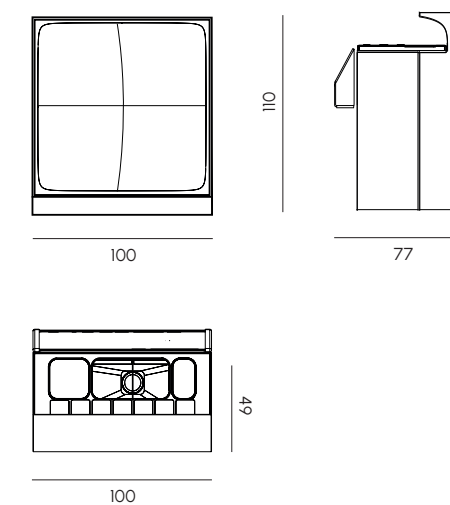



**Dublin modulo lineare**  
Dublin straight element

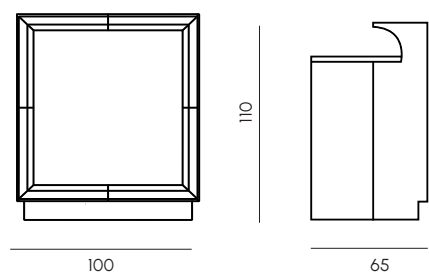

**Dublin modulo angolare**  
Dublin corner element

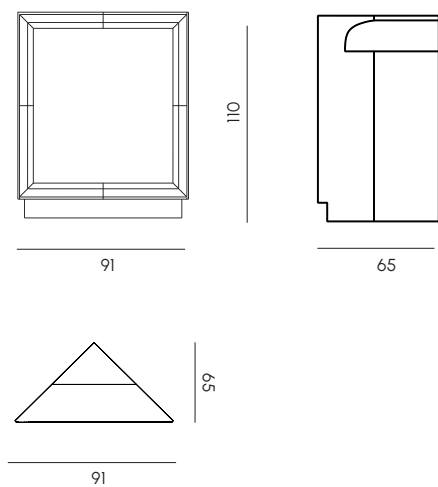

**Misure tridimensionali del bancone**  
Counter three-dimensional measures

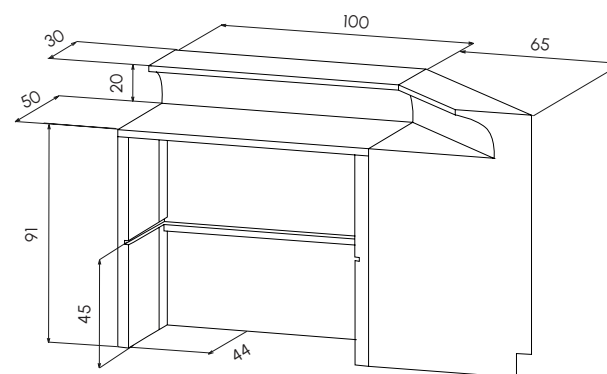

**Dublin modulo lineare con cocktail station ABS**  
Dublin straight element with ABS cocktail station

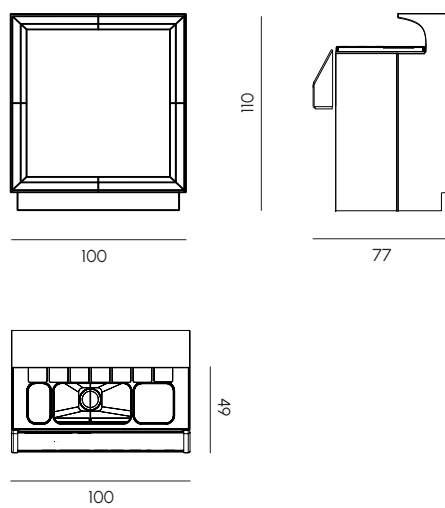

**Misure tridimensionali del bancone con cocktail station**  
Counter three-dimensional measures with cocktail station

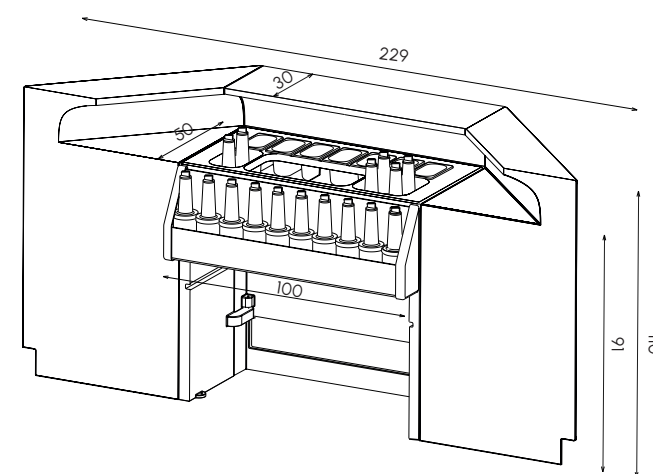



### Caratteristiche di Cocktail station M

#### Cocktail station M features

Realizzata in 2 componenti in ABS PMMA alimentare facile da pulire.  
 Installazione con aggancio rapido sia su Nova e Dublin.  
 Installabile ad incasso a piano.  
 Vasca ghiaccio con capienza fino a circa 60 kg.  
 Separatore amovibile per ghiaccio a cubetti o spezzato.  
 Piletta di scarico.  
 7 vani per vaschette H100 x L108 x W176 cad.  
 2 vani portabottiglie interni vasca (2 + 4).  
 Vaschette e bottiglie non sono incluse.

Made of 2 components in food-grade PMMA ABS easy to clean.  
 Installation with quick release both on Nova and Dublin.  
 It can be installed recessed in a worktop.  
 Ice tank with capacity up to about 60 kg.  
 Removable separator for ice in cubes or minced.  
 Drainage pipe.  
 7 compartments for bowls H100 x L108 x W176 each.  
 2 internal bottle rack compartments (2 + 4).  
 Bowls and bottles are not included.



### Speed rack

#### Speed rack

Realizzata in ABS PMMA alimentare facile da pulire.  
 Portata fino a 10 bottiglie (le bottiglie non sono incluse).  
 Elemento removibile.

Made of food-grade PMMA ABS easy to clean.  
 Capacity up to 10 bottles ( bottles are not included).  
 Removable element.



### Vasca

#### Sink

Rimuovendo il coperchio della cocktail station si può utilizzare la sola vasca portaghiaccio sfruttando la sua capienza fino a 80 Kg max.

Removing the cocktail station lid, you can only use the sink to 80 kgs maximum capacity.





**Sistema di montaggio**  
Assembling System

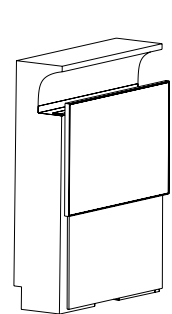

Modulo chiuso  
Closed element

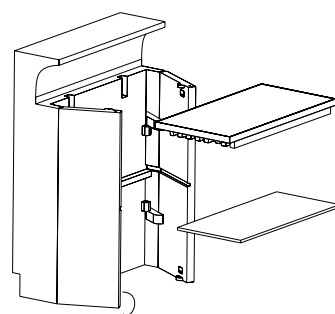

Aprire le due ante e inserire il piano  
Open the two sides and place the top

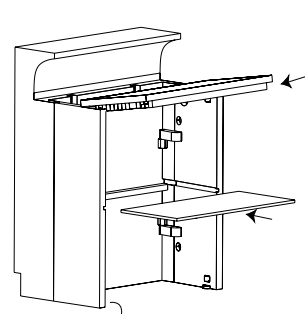

Inserire la mensola  
Place the shelf

**Volume trasportabile 20 m³**  
20 m³ transport capacity

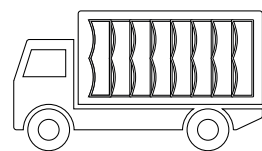

20 m³ corrispondono a 60 moduli lineari Nova o Dublin  
20 m³ matches 60 Nova or Dublin straight elements

**Sistema di alimentazione e cablaggi RGBW strip LED**  
RGBW strip LED power and wiring system

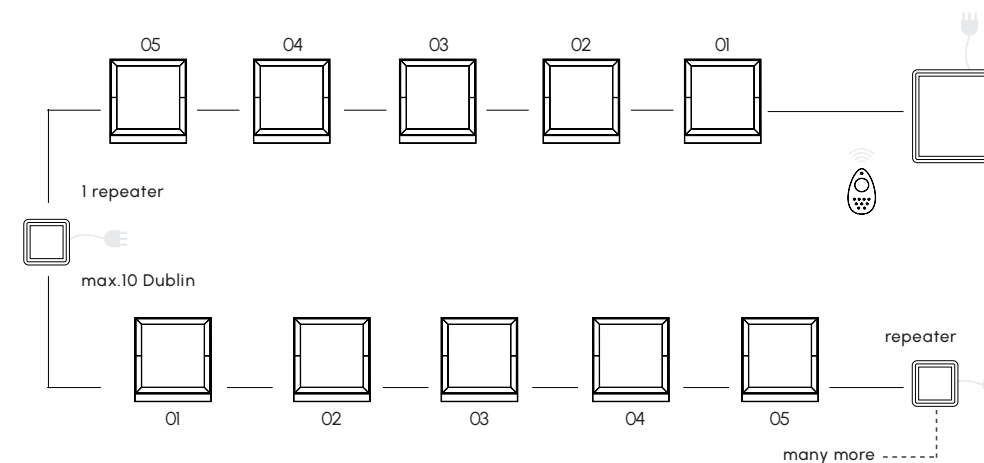

**Sistema di alimentazione e cablaggi luce E27**  
E27 power and wiring system

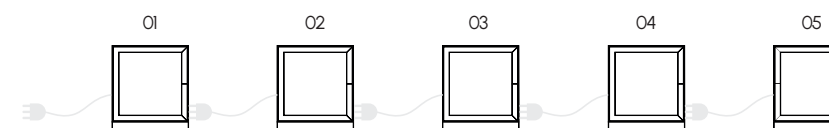



### Colori disponibili

Available colors

#### Finishing GS

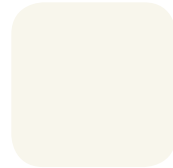

white  
117

#### Finishing VL



velvet beige  
804

#### Finishing OV



pearl gray  
180

#### Finishing OS

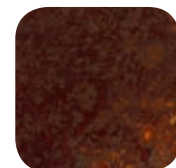

rust  
500

#### Finishing IL

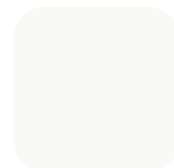

translucent  
110



velvet brown  
92



dark pearl  
162



copper  
101



velvet green\*  
208



velvet blue\*  
840

\* Per le finiture Velvet green e Velvet Blue la quantità minima ordinabile è di 6 pezzi  
For Velvet Green and Velvet Blue finishes the minimum order quantity is 6 pieces

Struttura e piano di lavoro	Poleasy®	Frame and working top	Poleasy®
Cerniere	Poleasy®	Hinges	Poleasy®
Cocktail station e speed rack	ABS	Cocktail station e speed rack	ABS
Mensola	HPL	Shelf	HPL
Kit di illuminazione dove previsto	E27 EXT * oppure RGBW LED 12W ** (controller necessario)	Lighting kit where applicable	E27 EXT * or RGBW LED 12W ** (necessary controller unit)

\* E27 EXT

lampadina di tipo E27 LED, max 20W - 230V 50/60Hz indice di protezione: IP44 (non incluse)  
E27 LED bulb, max 20W - 230V 50/60Hz, protection index: IP44 (not included)

\*\* RGBW LED 12W

Illuminazione: Strip Led 12W, Indice protezione: IP44  
Lighting type: Strip Led 12W, Protection index: IP44

Le immagini dei materiali e dei colori sono indicative, in quanto possono subire lievi variazioni in stampa.  
The materials and colors images serve as a mere indication, as they can vary slightly when printed.



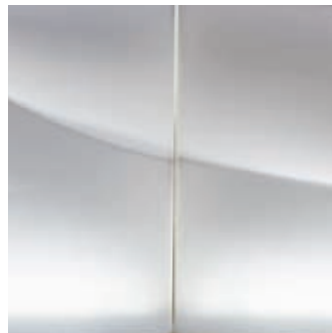

## Baraonda

Baraonda di MY YOUR è un'onda sinuosa che si trasforma in un bancone iconico e caratterizzante. In versione luminosa e non, trasportabile ovunque, facilmente richiudibile e stoccabile, Baraonda si adatta a molteplici utilizzi. L'eleganza avvolgente del design fa di Baraonda un elemento funzionale personalizzabile in grado di illuminare con infinite sfumature qualsiasi evento degno di nota. La funzionalità di Baraonda viene implementata dal modulo contenitore retrobanco Display, anch'esso illuminabile.

Baraonda by MY YOUR is a sinuous wave that transforms into an iconic and characterizing counter. Luminous or not, transportable anywhere, easily resealable and storable, Baraonda is suitable for multiple uses.

The enveloping elegance of the design makes Baraonda a customizable functional element able to light up with infinite shades any event worthy of note. The Baraonda functionality is implemented by the Display storage back counter element, which can also be illuminated.

### Baraonda modulo lineare Baraonda straight element

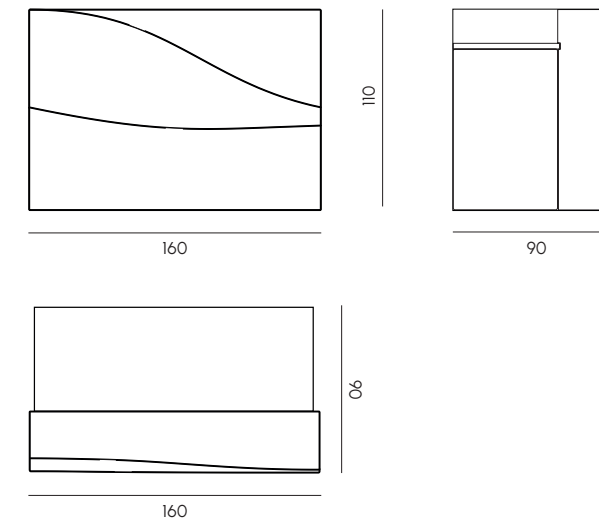

### Baraonda modulo angolare Baraonda corner element

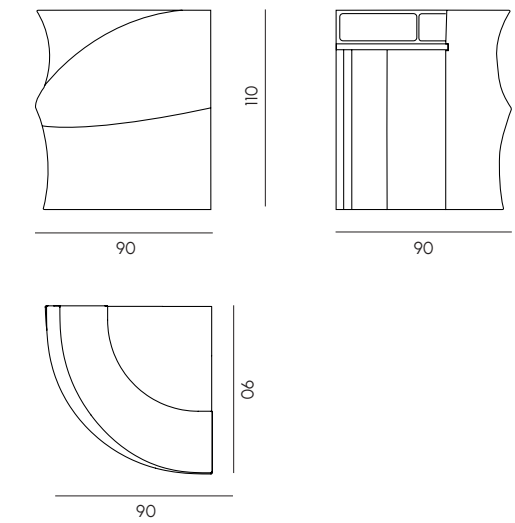

### Baraonda modulo lineare con cocktail station ABS Baraonda straight element with ABS cocktail station

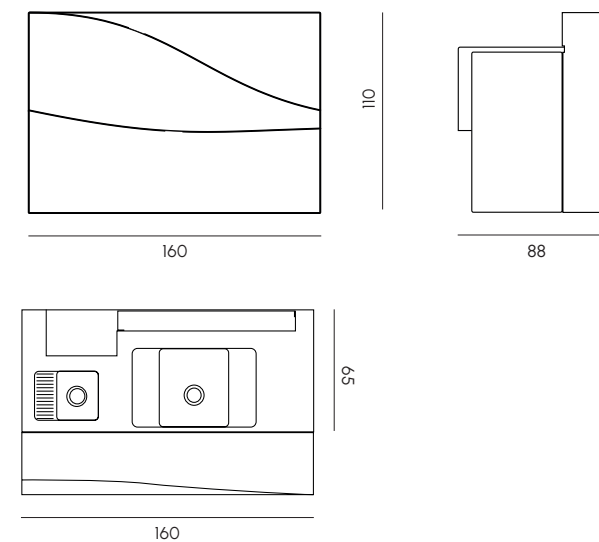

### Display modulo contenitore retrobanco Display back counter element

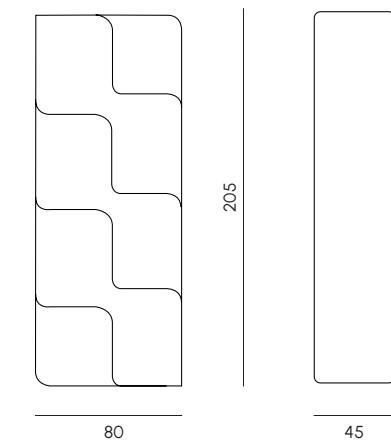



### Misure tridimensionali del modulo lineare e angolare

Straight and corner elements three-dimensional measures

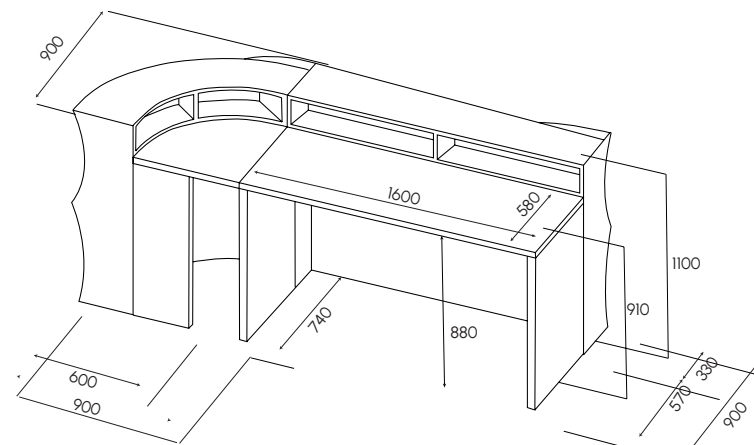

### Accessori

Optionals



Cocktail station  
Cocktail station

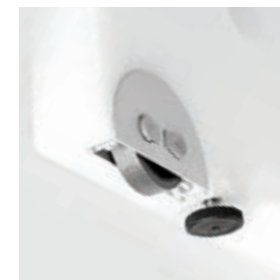

Kit con ruote e freni  
Wheels with brakes kit

### Sequenza di montaggio

Assembling steps



Modulo chiuso  
Closed element



Apertura fianchi  
Sides opening



Posizionamento piano  
Top positioning

### Esempio di composizione/ Baraonda bar-set luce RGBW

Set example/ Baraonda RGBW light system bar-set



6 x modulo lineare, 4 x modulo angolare, 1 x cocktail station, 1 x Display contenitore retrobanco, 1 x wireless controller, 2 x repeater.  
6 x straight element, 4 corner elements, 1 x cocktail station, 1 x Display back-counter shelf, 1 x wireless controller, 2 x repeater.



### Sistema di alimentazione e cablaggi RGBW strip LED

#### RGBW strip LED power and wiring system

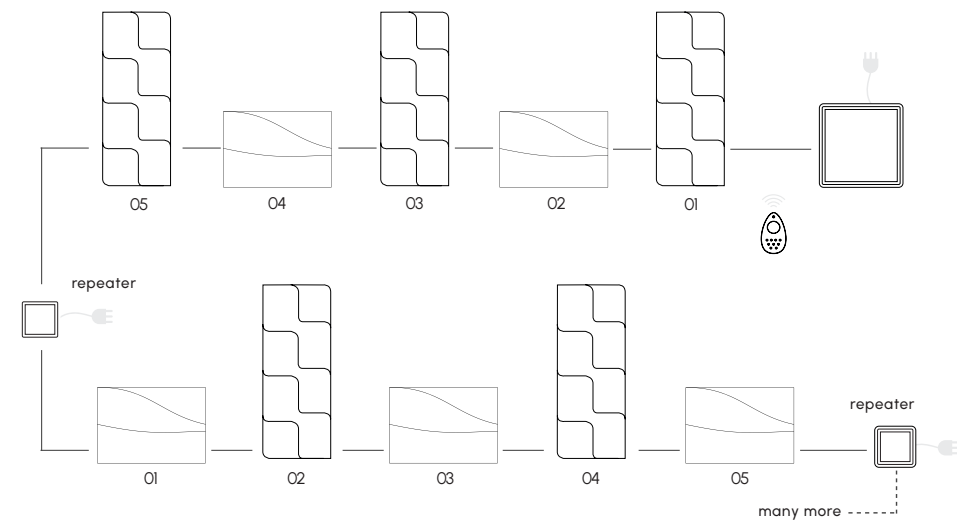

### Sistema di alimentazione e cablaggi luce E27

#### E27 power and wiring system

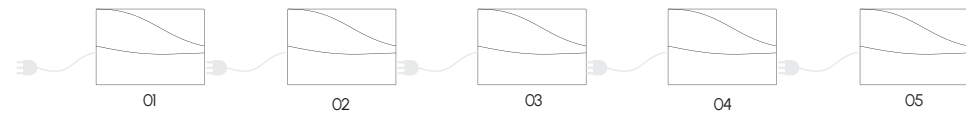

### Specifiche di trasporto e stoccaggio

#### Transport and storage specs

#### Smontaggio e stoccaggio

##### Disassembling and storage

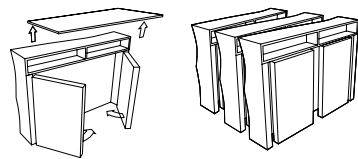

Seguire istruzioni come da disegno  
Follow the instructions in the drawing.

#### Volume trasportabile 20 m<sup>3</sup>

##### 20 m<sup>3</sup> transport capacity

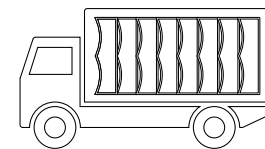

20 m<sup>3</sup> corrispondono a 30 moduli lineari Baraonda  
20 m<sup>3</sup> matches 30 Baraonda straight elements

Struttura	Poleasy®	Frame	Poleasy®
Piano di lavoro	Laminato	Hinges	Laminate
Cerniere	Inox	Hinges	Inox
Cocktail station	ABS bianco rinforzato in vetroresina, miscelatore e pilette di scarico in ottone cromato e barra speed rack in inox satinato	Hinges	ABS white hardened fiberglass, chromed brass mixer tap and waste drain, and satin stainless steel speed rack bar
Kit di illuminazione dove previsto	E27 EXT * oppure RGBW LED 12W ** (controller necessario)	Lighting kit where applicable	E27 EXT * or RGBW LED 12W ** (necessary controller unit)

\* E27 EXT

2 pz lampadine di tipo E27 fluorescente compatta, da max 32W - 230V 50/60Hz, indice di protezione: IP44 (non incluse)  
2 pieces E27 compact fluorescent bulb, max 32W - 230V 50/60Hz, protection index: IP44 (not included)

\*\* RGBW LED 12W

Illuminazione: Strip Led 36W, Indice protezione: IP44  
Lighting type: Strip Led 36W, Protection index: IP44

### Colori disponibili

#### Available colors

#### Finishing

##### GS

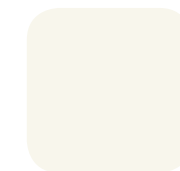

white  
117

#### Finishing

##### OS



rust  
500

#### Finishing

##### IL

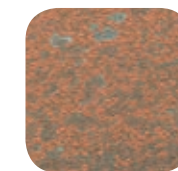

copper  
101

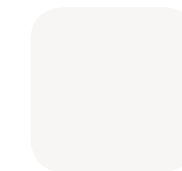

translucent  
110

Le immagini dei materiali e dei colori sono indicative, in quanto possono subire lievi variazioni in stampa.  
The materials and colors images serve as a mere indication, as they can vary slightly when printed.



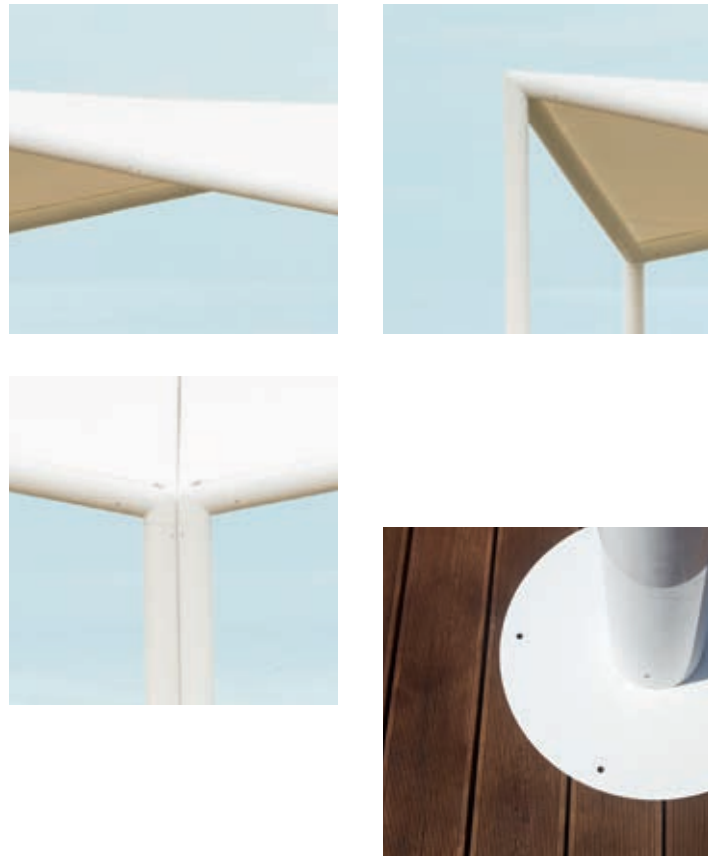

## Kite

Kite è la vela ombreggiante high-tech progettata da MY YOUR R&D. E' perfetta per ospitare eventi outdoor di qualsiasi tipo. In due dimensioni, si può comporre in multipli per la realizzazione di grandi coperture. Kite è composto da una solida struttura autoportante dotata di quattro pali in acciaio e dalla telonatura che permette stabilità e impermeabilità in caso di maltempo. Le modalità di tensionamento della vela garantiscono resistenza ed eccellenti prestazioni anche in caso di vento. Di facile manutenzione e pulizia, Kite è disponibile solo nella versione full white.

Kite is the high-tech sun sail developed by MY YOUR R&D. It's perfect for hosting any type of outdoor events. In two sizes, it can be composed in multiples for the realization of large roofs. Kite is composed of a solid self-supporting structure equipped with four steel poles and the tarp that allows stability and water-proofing in bad weather. The sail tensioning modes guarantee resistance and excellent performance even in windy conditions. Easy to maintain and clean, Kite is only available in the full white version.

**Modulo 5 x 5**  
5 x 5 element

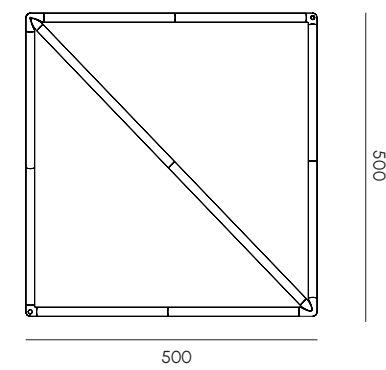
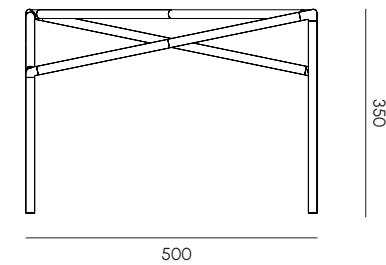

**Modulo 5 x 5/ Copertura**  
5 x 5 element/ Sun cover

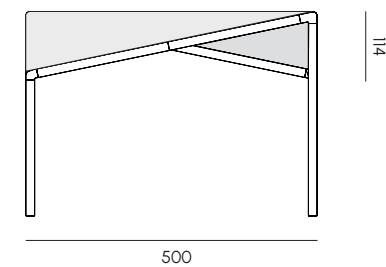

**Modulo 6 x 6**  
6 x 6 element

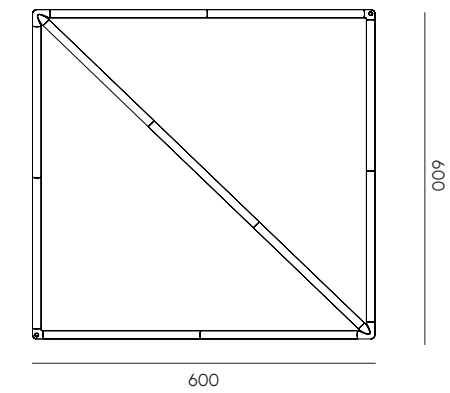
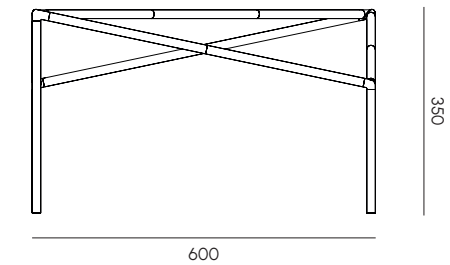

**Modulo 6 x 6/ Copertura**  
6 x 6 element/ Sun cover

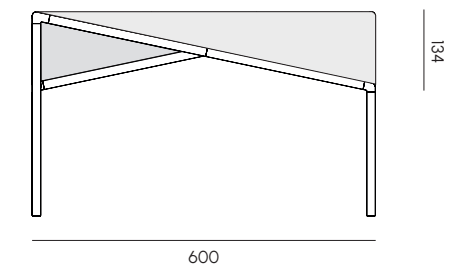



**Basamento**  
Base

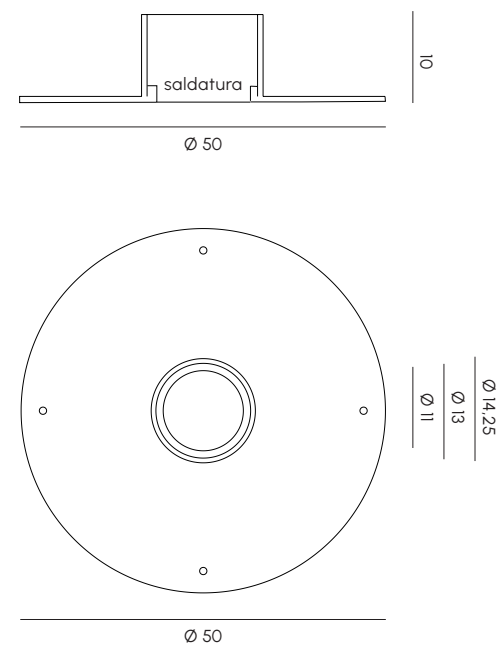

Fixing hole Ø 0.5 mm

**Caratteristiche**  
Features

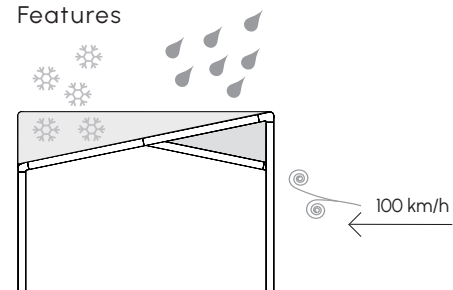

Snow load: 20 cm. 120 daN/m<sup>2</sup>

Kite necessita di altre piastre autoportanti a forma semicircolare e ad arco per le varie configurazioni. Tutte le informazioni a riguardo su listino.  
Kite needs other self-supporting semicircular and arc shaped plates for various configurations. All the concerning specs in pricelist.

Struttura e basamento	Acciaio 316 verniciato a polveri in RAL 9016
Telonatura	Tela spalmata in PVC idrorepellente di derivazione nautica

Frame and base	RAL 9016 powder-coated steel 316
Tarp	Waterproof coated nautically derived PVC tarp

**Configurazioni**  
Configurations

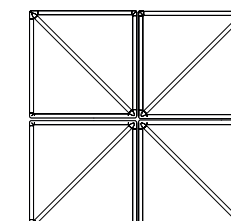
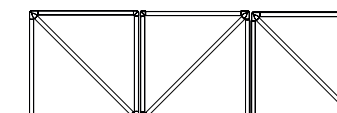
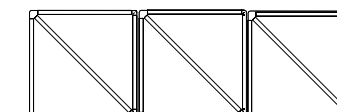





**Paletto**  
Pole

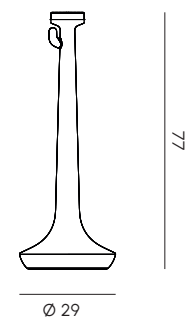

**Dispenser**  
Dispenser

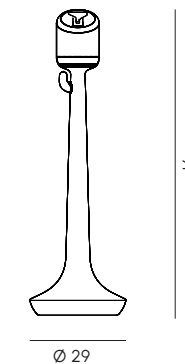

Massima capacità del dispenser: 1 L  
Dispenser maximum capacity: 1 L

**Posacenere**  
Ashtray

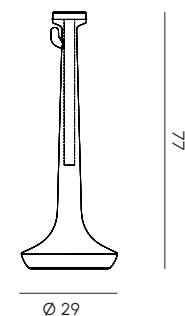

Capacità massima del portacenere: 300 sigarette  
Ashtray maximum capacity: 300 cigarettes

**Bobina di corda**  
Rope coil

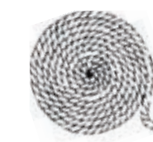

Diametro della corda: 14 mm  
Lunghezza massima della corda: 100 m  
Rope width: 14 mm  
Rope maximum length: 100 m

## Flamingo

Tutti gli spazi legati alla collettività necessitano di percorsi per gestire i flussi e garantire accessibilità e distanze di sicurezza. MY YOUR presenta Flamingo, il separatore di ambienti, disegnato da More Design, in grado di soddisfare questa funzionalità. Flamingo è un sistema divisorio in multipli che permette di perimetrare gli spazi creando percorsi e di dividere gli stessi in modo personalizzato. Alla base si trova una zavorra che evita il fissaggio a terra ne permette il posizionamento. Flamingo è interamente realizzato in Poleasy® e dotato di accessori per segnaletica, di posacenere e dispenser.

All spaces linked to the community need paths to manage flows and ensure accessibility and safe distances. MY YOUR shows Flamingo, the space separator, designed by More Design, able to satisfy this functionality. Flamingo is a partition system in multiples that allows you to perimeter the spaces creating paths and divide them in a personalized way. At the base there is a ballast that avoids fixing to the ground allows its positioning. Flamingo is entirely made of Poleasy® and equipped with optionals for signage, ashtray and dispenser.



Struttura

Poleasy®

Frame

Poleasy®

### Colori disponibili

Available colors

Finishing  
GS



white  
117



gray  
87



neutral

Finishing\*  
PL

\*Solo per la corda  
Only for the rope

Le immagini dei materiali e dei colori sono indicative, in quanto possono subire lievi variazioni in stampa.  
The materials and colors images serve as a mere indication, as they can vary slightly when printed.





Struttura

Poleasy®

Frame

Poleasy®

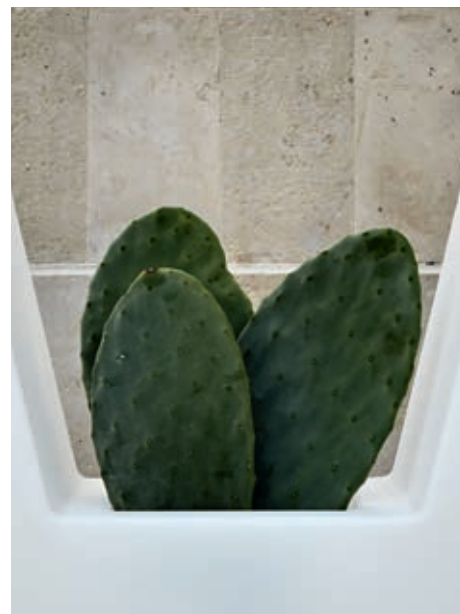

#### NonVaso con fioriera Planter element

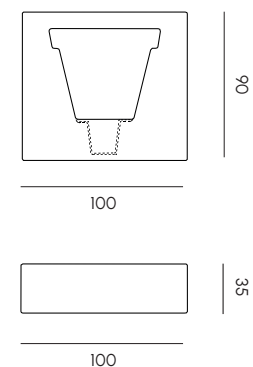

#### Colori disponibili Available colors

#### Finishing GS

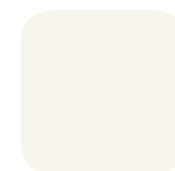

white  
117

#### NonVaso

NonVaso è il sistema divisorio disegnato da Massimo Zaniboni per MY YOUR. L'idea nasce dal coniugare il concetto di vaso nella sua forma archetipa e quello di complemento in grado di dividere e recintare il perimetro degli ambienti in cui è inserito. La possibilità decorativa di inserire al suo interno piante e fiori consente una totale versatilità. Realizzato in Poleasy®, anche in versione luminosa, è resistente agli agenti atmosferici, si mantiene e si pulisce facilmente.

NonVaso is the partition system designed by Massimo Zaniboni for MY YOUR. The idea was born from combining the concept of vase in its archetypal shape and that of complement able to divide and fence the spaces perimeter in which it is placed. The decorative possibility to put inside plants and flowers allows a total versatility. Made of Poleasy®, also in a luminous version, it is resistant to atmospheric agents, it's easy to maintain and clean.

Le immagini dei materiali e dei colori sono indicative, in quanto possono subire lievi variazioni in stampa.  
The materials and colors images serve as a mere indication, as they can vary slightly when printed.



### NonVaso con fioriera e luce

Light planter element

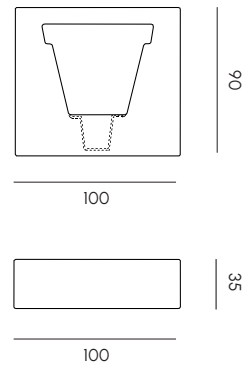

### Colori disponibili

Available colors

### Finishing

IL



translucent  
110

Struttura	Poleasy®	Frame	Poleasy®
Fonte luminosa	N° 2 lampadine E27 LED, max 20W-230V 50/60 Hz in base alla misura (non fornite)	Light source	N° 2 E27 LED bulb, max 20W-230V 50/60 Hz depending on the size (not included)
Alimentazione	100-240V 50/60Hz	Power Supply	100-240V 50/60Hz
Indice di protezione cavo di ricarica	IP44	Cable IP	IP44
Lunghezza cavo	2 m	Cable length	2 m
Switch	Spina	Switch	Plug

Le immagini dei materiali e dei colori sono indicative, in quanto possono subire lievi variazioni in stampa.  
The materials and colors images serve as a mere indication, as they can vary slightly when printed.



Struttura e zavorre

Poleasy®

Piastrine autoportanti

Acciaio 316 laccato a polveri  
con trattamento di cataforesi RAL 9016

Frame and ballasts

Poleasy®

Self-supporting plates

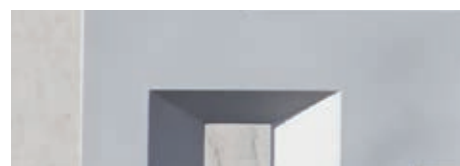
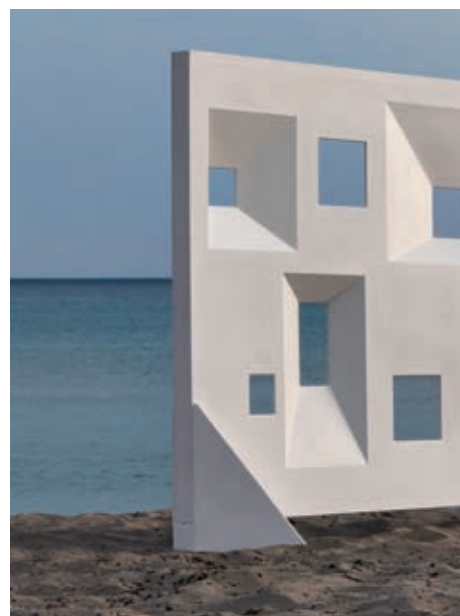
Powder coated 316 steel  
with cataphoresis treatment Ral 9016

### Modulo Element

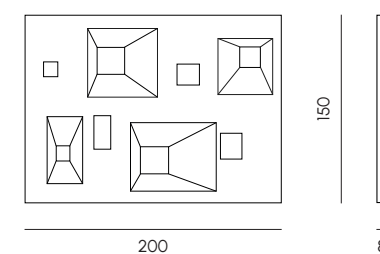

### Zavorre e piastre autoportanti Ballasts and self-supporting plates

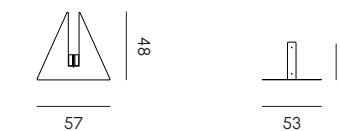

### Frames

Frames è un sistema modulare di separatori d'ambiente zavorrato disegnato da Brogliato Traverso per MY YOUR. Il modulo singolo può essere posizionato orizzontalmente. La decorazione, di derivazione razionalista, gioca sul concetto di vuoti e pieni prospettici. Come piccole le fenditure formano scorci geometrici e volumetrici in cui guardare affinché si crei e si amplii un rapporto visivo fra le aree delimitate. Realizzato in Poleasy®, minimale e facilmente trasportabile, è testato per gli agenti atmosferici ed alle incurie del tempo.

Frames is a modular system of ballasted room dividers designed by Brogliato Traverso for MY YOUR. The single module can be positioned horizontally. The decoration, of rationalist derivation, plays on the concept of empty and full perspective. Like small slits, they form geometric and volumetric glimpses in which to look for a visual relationship between the delimited areas to be created and expanded. Made of Poleasy®, minimal and easily transportable, it is tested for weathering and the neglect of time.

### Colori disponibili Available colors

### Finishing GS

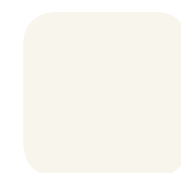
white  
117gray  
87

Le immagini dei materiali e dei colori sono indicative, in quanto possono subire lievi variazioni in stampa.  
The materials and colors images serve as a mere indication, as they can vary slightly when printed.



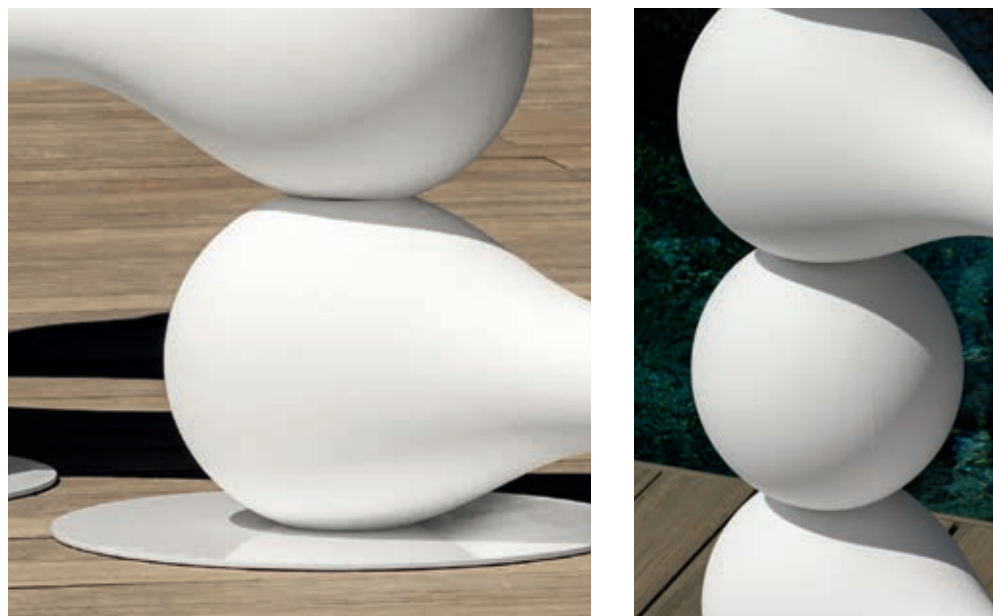

**Modulo Ba\_Gigio**  
Bagigio element

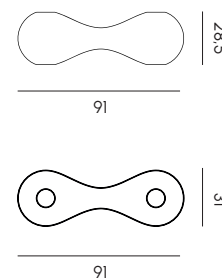

**Base autoportante e piastra fissaggio**  
Self-supporting base and fixing plate

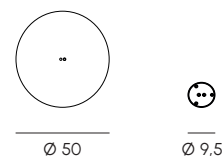

**Modulo Gigio**  
Gigio element

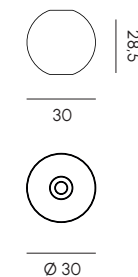

**Tubo**  
Pipe

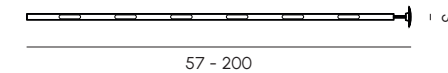

## Ba\_Gigio

Ba\_Gigio è separatore, cinta perimetrale ed elemento decorativo scultoreo disegnato da Simone Micheli per MY YOUR. L'architetto interpreta il progetto come "un elemento componibile senza limiti a rappresentazione tridimensionale del simbolo dell'infinito, nato dalla rivoluzione dello stesso intorno al proprio asse e come macroimmagine spaziale di un legame atomico bipolare". Bagigio è un elemento che plasma lo spazio e lo suddivide con una forte caratterizzazione, diventandone il protagonista. In diverse componibilità e altezze, è disponibile nella versione full-white gofrata stampata.

Ba\_Gigio is a partition, perimeter wall and sculptural decorative element designed by Simone Micheli for MY YOUR. The architect interprets the project as "a modular element without limits to three-dimensional representation of the symbol of infinity, born from the revolution of the same around its axis and as a spatial macroimage of a bipolar atomic bond". Ba\_Gigio is an element that shapes the space and divides it with a strong characterization, becoming its protagonist. It is available in a full-white embossed printed version and in different sectional and heights.



### Schema di montaggio

Assembling scheme

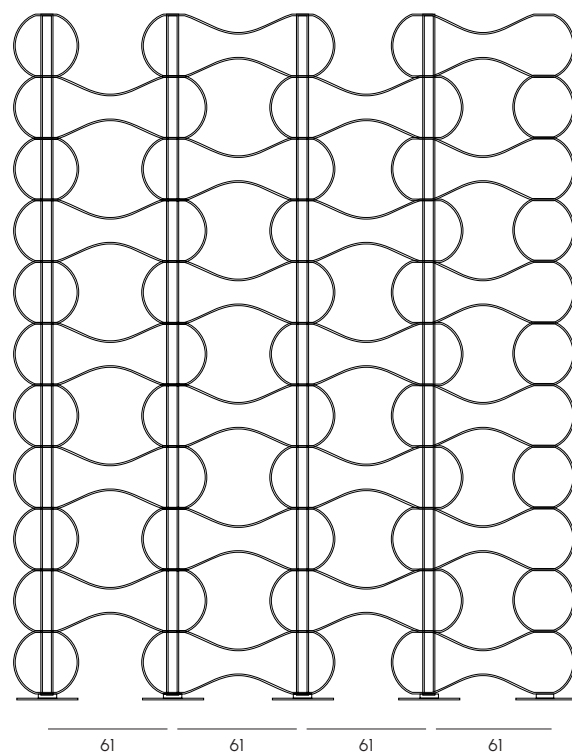

Struttura	Poleasy®	Frame	Poleasy®
Base autoportante	Ferro 360 laccato a polveri RAL 9016	Self-supporting base	RAL 9016 Powder-coated iron 360
Piastra fissaggio	Acciaio 316 passivato (per ambienti marini) con trattamento di cataforesi	Fixing plate	316 passivated steel (for marine spaces) with treatment of cataphoresis
Tubi	FE verniciato con trattamento di cataforesi o su richiesta per ambienti marini in Acciaio 316 passivato	Pipes	FE painted with cataphoresis treatment or on request for marine environments in passivated 316 steel

### Colori disponibili

Available colors

#### Finishing

GS

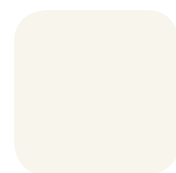

white  
117

Le immagini dei materiali e dei colori sono indicative, in quanto possono subire lievi variazioni in stampa.  
The materials and colors images serve as a mere indication, as they can vary slightly when printed.





## Cloe

Il suo nome in greco antico significa "fresco" e "giovane". Allo stesso modo MY YOUR interpreta il concetto di lettino da sole con Cloe, disegnato da More Design, attraverso un design sinuoso e organico che forma un'onda maestosa e fresca. Scultorea, elegante, versatile, Cloe è adatta a qualsiasi ambiente esterno, può essere parzialmente immersa in acqua per la collocazione in piscina e in mare. Realizzata in Poleasy®, al 100% riciclabile, di facile pulizia, resiste agli agenti atmosferici e ai raggi UV.

Its name in ancient Greek means "fresh" and "young". Likewise, MY YOUR plays the concept of a sunbed with Cloe, designed by More Design, through a sinuous and organic design that forms a majestic and fresh wave. Sculptural, elegant, versatile, Cloe is suitable for any outdoor space, can partially submerged in water for being placed in the pool and in the sea. Made in Poleasy®, 100% recyclable, easy to clean, it resists to atmospheric agents and UV rays.

Struttura	Poleasy®
Accessori	Spugna in 100% cotone

Frame	Poleasy®
Optional	100% cotton sponge towel

## Cloe

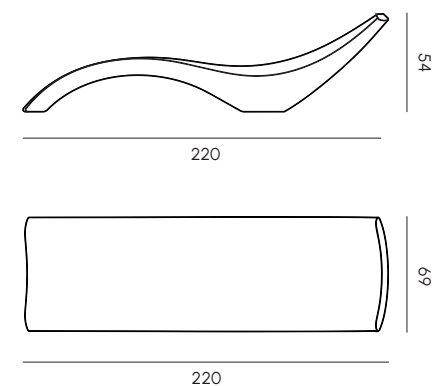

## Spugna bianca

White sponge towel

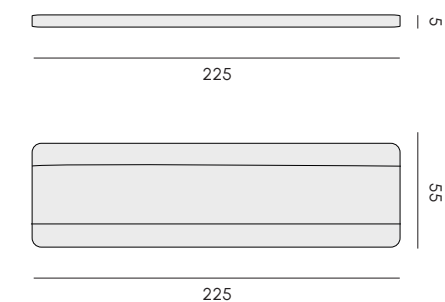

## Colori disponibili\*

Available colors

## Finishing

GS

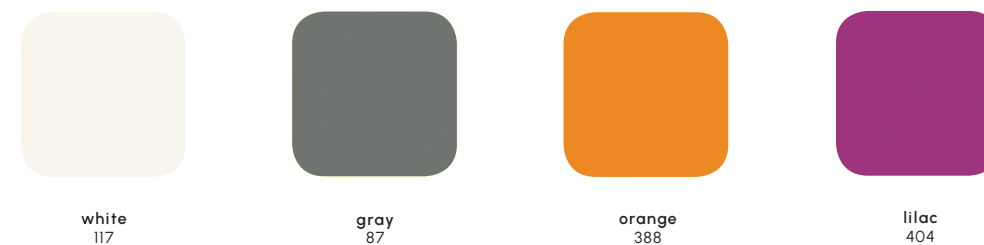

Le immagini dei materiali e dei colori sono indicative, in quanto possono subire lievi variazioni in stampa.  
The materials and colors images serve as a mere indication, as they can vary slightly when printed.



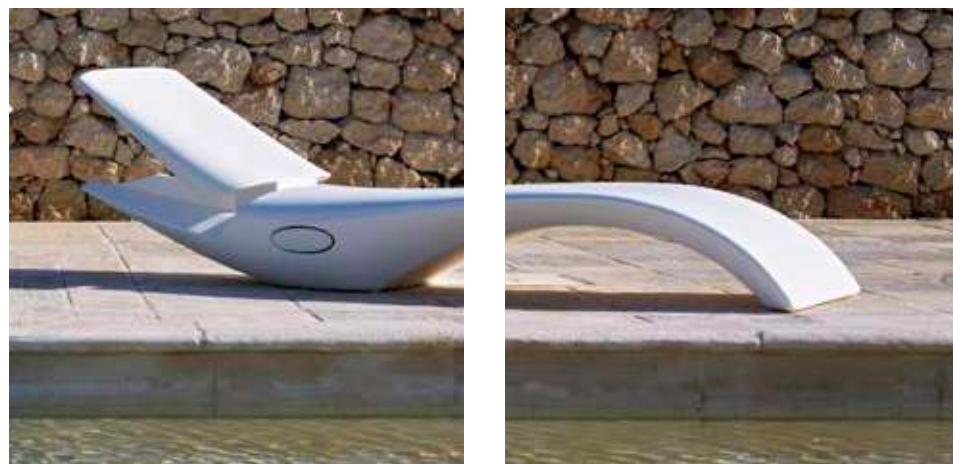

## Zoe

Il lettino Zoe, ideato da More Design per MY YOUR, è la naturale evoluzione di Cloe. La sua funzionalità garantisce performance eccellenti in termini di comodità grazie allo schienale regolabile che consente diverse posizioni attraverso l'impiego di un pistone a gas azionabile da un pulsante. La scocca, interamente riciclabile e realizzata in Poleasy® contiene dispositivi metallici cromati e testati per resistere agli agenti atmosferici. Zoe è, pertanto, un lettino da sole irrinunciabile per arredare piscine, stabilimenti balneari e giardini in cui il relax sia accompagnato da solidità, robustezza e da un design decisamente distintivo.

The Zoe sun bed, designed More Design for MY YOUR, is the Cloe's natural evolution. Its functionality guarantees excellent performance in terms of comfort thanks to the adjustable backrest that allows different positions through the use of an operated by a button gas piston. The shell, fully recyclable and made of Poleasy® contains metal chrome-plated devices and tested to withstand atmospheric agents.

Zoe is, therefore, an essential sun bed to furnish swimming pools, beach resorts and gardens where relaxation is accompanied by solidity, strength and a definely distinctive design.

Struttura	Poleasy®
Accessori	Spugna in 100% cotone

Frame	Poleasy®
Optional	100% cotton sponge towel

## Cloe

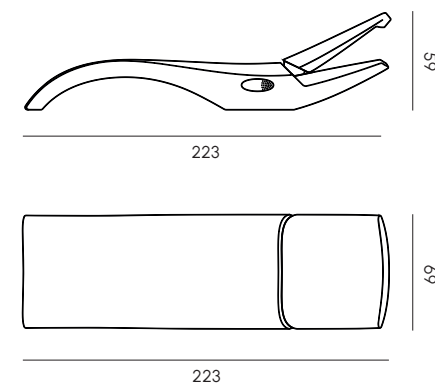

## Spugna bianca

White sponge towel

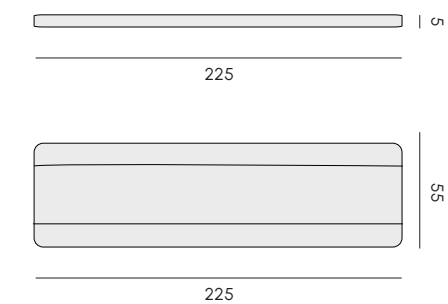

## Colori disponibili

Available colors

## Finishing

GS

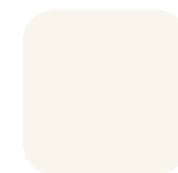

white  
117

**Le immagini dei materiali e dei colori sono indicative, in quanto possono subire lievi variazioni in stampa.**  
The materials and colors images serve as a mere indication, as they can vary slightly when printed.





## Bali

Bali è un beach-set composto da lettino, tavolino e ombrellone, dalla perfetta sintesi di comfort, estetica e funzionalità. Il lettino Bali, la cui struttura è in polipropilene e il tessuto in poliestere e PVC, ha lo schienale regolabile in 5 posizioni e può essere impilato fino a 14 unità. Il suo design organico si ispira allo stile tipico dell'isola indonesiana ed è testato per resistere ai raggi UV e agli agenti atmosferici. A corredo il tavolino da sole e l'ombrellone, in tessuto acrilico, base in cemento e struttura d'acciaio, disponibile in due versioni: tondo dal diametro di 2,5 m oppure quadrato con lato di 2 m.

Bali is a beach-set consisting of a sun bed, table and umbrella, with the perfect synthesis of comfort, aesthetics and functionality. The Bali bed, whose structure is done in polypropylene and the fabric in polyester and PVC, has an adjustable backrest in 5 positions and can be stacked up to 14 units. Its organic design is inspired by the typical Indonesian style and is tested to withstand UV rays and weathering. In support the coffee table and the umbrella, in acrylic fabric, concrete base and steel structure, available in two versions: round with a 2.5 m diameter or square with a 2 m side.

Struttura	Polipropilene	Frame	Polipropilene
Rivestimento seduta	Rete 70% PVC e 30% Poliestere	Seat cover	70% PVC and 30% Polyester stige

### Lettino Sunbed

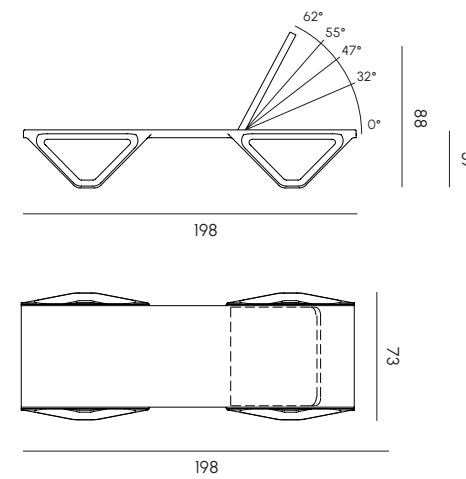

### Tavolino Side table

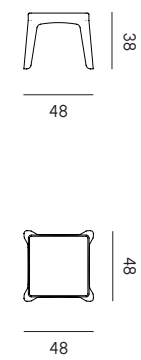

### Abbinamenti lettini Sunbed combinations

#### Finishing PP

#### Tessuto Fabric



white  
01



white  
0400



sand  
0500

Le immagini dei materiali e dei colori sono indicative, in quanto possono subire lievi variazioni in stampa.  
The materials and colors images serve as a mere indication, as they can vary slightly when printed.



**Ombrellone quadrato**  
Square sun umbrella

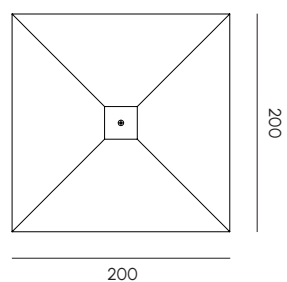
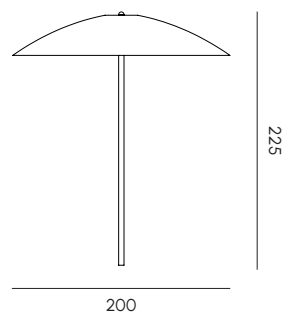

**Ombrellone ottagonale**  
Octagonal sun umbrella

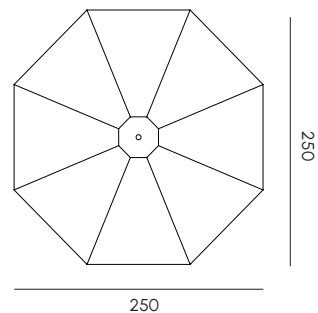
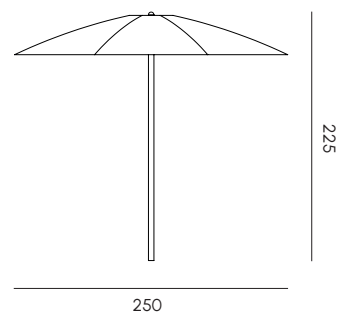

**Zavorra ombrellone\***  
Sun umbrella ballast

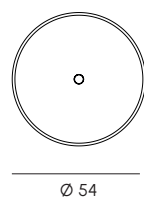
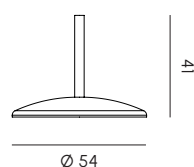

\*Disegno non in scala  
Not scaled drawing

Parasole	Poliammide	Parasol	Polyamide
Palo	Inox inossidabile	Pole	Stainless steel
Zavorra	Cemento	Ballast	Concrete

**Finiture disponibili**  
Available finishes

**Zavorra**  
Ballast

**Palo**  
Pole

**Parasole**  
Parasol



concrete



stainless steel



polyamide white

Le immagini dei materiali e dei colori sono indicative, in quanto possono subire lievi variazioni in stampa.  
The materials and colors images serve as a mere indication, as they can vary slightly when printed.





## Dyno

Dyno è la doccia per esterni ideata da More Design per MY YOUR, la cui forma fluida e organica è esaltata dalla qualità di lavorazione e dalla tecnologia. Dyno è perfetta per chi vuole personalizzare il proprio spazio outdoor con un design fortemente distintivo. Realizzata in Poleasy® e abbinabile alla base per doccia Paw in ABS bianco è dotata di profili per trattenere la sabbia ed è rivestita con un film acrilico che rende più efficaci, comode e sicure le operazioni di pulizia. Dyno è stabilizzata per resistere ai raggi UV e agli agenti atmosferici.

Dyno is the outdoor shower designed by More Design for MY YOUR, whose fluid and organic shape is enhanced by the quality of workmanship and technology. Dyno is perfect for those who want to customize their outdoor space with a highly distinctive design. Made of Poleasy® and combinable with Paw base for shower in white ABS it's equipped with profiles to retain the sand and is coated with an acrylic film that makes cleaning operations more effective, comfortable and safe. Dyno is stabilized to withstand UV rays and weathering.

Struttura	Poleasy®
Struttura base PAW	ABS bianco
Rubinetteria	ABS cromato

Frame	Poleasy®
PAW base frame	White ABS
Faucet	Chrome-plating ABS

## Dyno

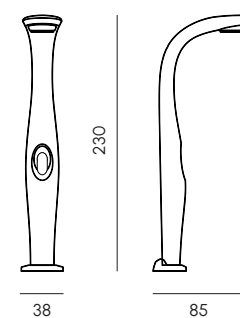

## Paw

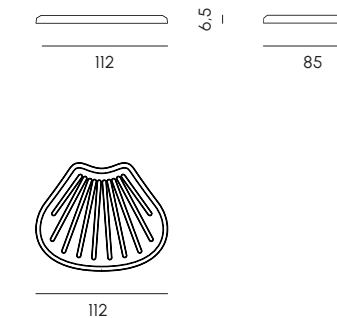

## Colori disponibili\*

Available color

## Finishing

GS

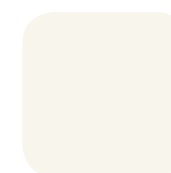

white  
117

\* Disponibile nella versione con temporizzatore fino a esaurimento scorte  
Available with timer while stocks last

**Le immagini dei materiali e dei colori sono indicative, in quanto possono subire lievi variazioni in stampa.**  
The materials and colors images serve as a mere indication, as they can vary slightly when printed.





Struttura

Poleasy®

Frame

Poleasy®

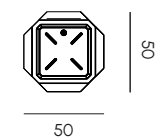
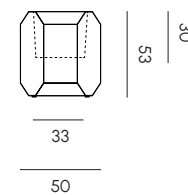
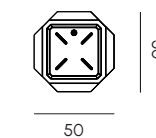
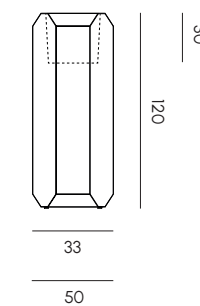
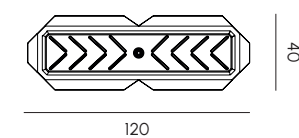
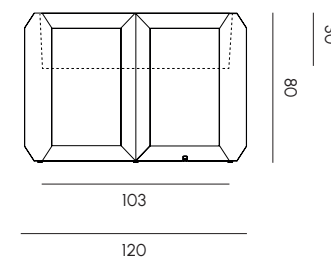
Gem S  
Gem SGem M  
Gem MGem fioriera, ice-box  
Gem planter, ice-box

## Gem

Vasi scolpiti come un taglio di pietre preziose. La collezione Gem, di Paolo Cappello per MY YOUR, è proprio questo. Come monoliti raffinati in tre misure, i vasi Gem diventano protagonisti multifunzionali dello spazio poichè possono sia decorarlo, sia perimetrarlo o entrambe le cose. Appaiandosi, infatti, i tre formati possono comporre con differenti possibilità un divisorio o un cinto perimetrale. Disponibili anche in versione luminosa e con fioriera ad uso ice-box. Realizzati in Poleasy®, riciclabili al 100%, si puliscono facilmente e resistono nel tempo agli agenti atmosferici.

Carved vases like a cut of precious stones. The Gem collection, by Paolo Cappello for MY YOUR, is just that. As refined monoliths in three sizes, they are multifunctional protagonists of the space as they can either decorate it, or perimeter it or both. By matching, in fact, the three sizes can compose a partition or a perimeter belt with different possibilities. Also available in luminous version and with planter for ice-box use. Made of 100% recyclable Poleasy®, they are easy to clean and weather resistant.



Colori disponibili  
Available colors

Finishing  
GS

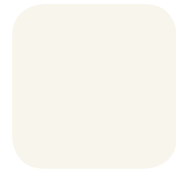

white  
117

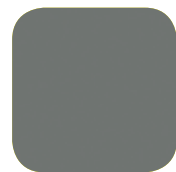

gray  
87

Finishing  
VL



velvet beige  
804



velvet brown  
92



velvet green\*  
208



velvet blue\*  
840

Finishing  
OV



pearl gray  
180



dark pearl  
162

Finishing  
OS

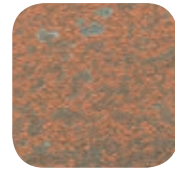

copper  
101



rust  
500

\* Per le finiture Velvet green e Velvet Blue la quantità minima ordinabile è di 6 pezzi  
For Velvet Green and Velvet Blue finishes the minimum order quantity is 6 pieces

Le immagini dei materiali e dei colori sono indicative, in quanto possono subire lievi variazioni in stampa.  
The materials and colors images serve as a mere indication, as they can vary slightly when printed.





### Gem S luminoso

Light Gem S

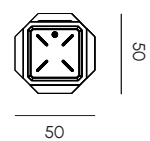
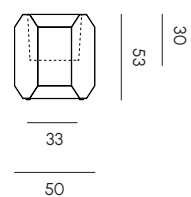

### Gem M luminoso

Light Gem M

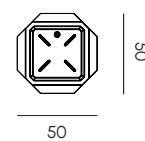
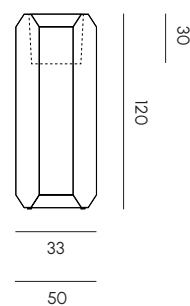

### Gem fioriera, ice-box luminoso

Light em planter, ice-box

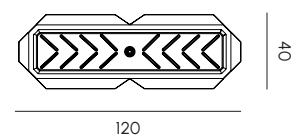
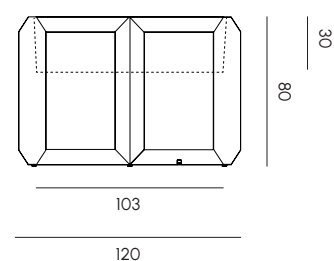

Struttura	Poleasy®	Frame	Poleasy®
Fonte luminosa	N° 1 o 2 lampadine E27 LED, max 20W-230V 50/60 Hz in base alla misura (non fornite)	Light source	N° 1 or 2 E27 LED bulb, max 20W-230V 50/60 Hz depending on the size (not included)
Alimentazione	110-240V 50/60Hz	Power Supply	110-240V 50/60Hz
Indice di protezione cavo di ricarica	IP44	Cable IP	IP44
Lunghezza cavo	2 m (cavo bianco con spina)	Cable length	2 m (white cable with plug)
Switch	Spina	Switch	Plug

### Colori disponibili

Available colors

### Finishing

IL

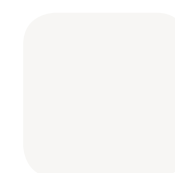

translucent  
110

Le immagini dei materiali e dei colori sono indicative, in quanto possono subire lievi variazioni in stampa.  
The materials and colors images serve as a mere indication, as they can vary slightly when printed.



Struttura

Poleasy®

Frame

Poleasy®

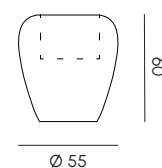
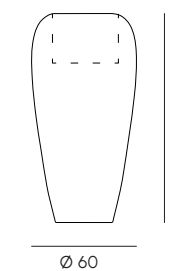
Skin S  
Skin SSkin L  
Skin L

## Skin

Skin è la collezione di vasi, in tre dimensioni, disegnata da Isabella Lovero ed Enrico Bosa per MY YOUR. Di ispirazione neoclassica il design-plus si ritrova nella tridimensionalità della texture che ne enfatizza le forme e la morbidezza al tatto. Realizzati in Poleasy®, i vasi Skin sono disponibili nelle finiture ossidate e goffrate stampate e nella finitura trasparente per la versione illuminabile. Decorativi ed eleganti conferiscono allo spazio un'atmosfera borghese e contemporanea. Di facile pulizia, resistono agli agenti atmosferici e ai raggi UV.

Skin is the vases collection, in three sizes, designed by Isabella Lovero and Enrico Bosa for MY YOUR. Neoclassical inspiration design-plus is found in the texture three-dimensionality that emphasizes the shapes and softness to the touch. Made of Poleasy®, Skin vases are available in oxidized and embossed printed finishes and transparent finish for the lightable version. Decorative and elegant they give the space a bourgeois and contemporary atmosphere. Easy to clean, they resist atmospheric and UV rays.



Colori disponibili  
Available colors

Finishing  
GS

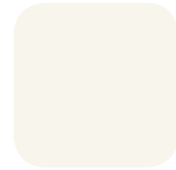

white  
117

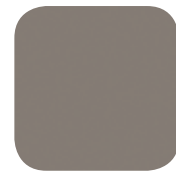

beige  
212

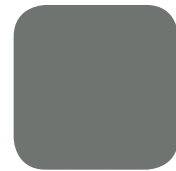

gray  
87

Finishing  
OV



pearl gray  
180



dark pearl  
162

Finishing  
OS

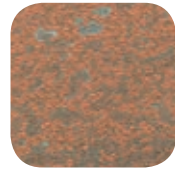

copper  
101

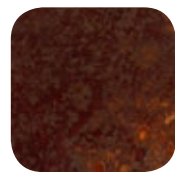

rust  
500

Le immagini dei materiali e dei colori sono indicative, in quanto possono subire lievi variazioni in stampa.  
The materials and colors images serve as a mere indication, as they can vary slightly when printed.





**Skin S luminoso**  
Light Skin S

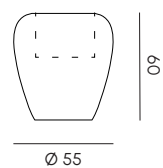

**Skin L luminoso**  
Light Skin L

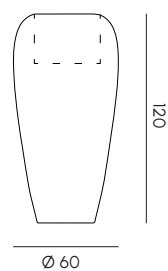

Struttura	Poleasy®	Frame	Poleasy®
Fonte luminosa	N° 1 lampadine E27 LED, max 20W-230V 50/60 Hz in base alla misura (non fornite)	Light source	N° 1 E27 LED bulb, max 20W-230V 50/60 Hz depending on the size (not included)
Alimentazione	100-240V 50/60Hz	Power Supply	100-240V 50/60Hz
Indice di protezione cavo di ricarica	IP44	Cable IP	IP44
Lunghezza cavo	2 m (cavo bianco con spina)	Cable length	2 m (white cable with plug)
Switch	Spina	Switch	Plug

**Colori disponibili**  
Available colors

**Finishing**  
IL

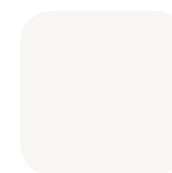

translucent  
110

Le immagini dei materiali e dei colori sono indicative, in quanto possono subire lievi variazioni in stampa.  
The materials and colors images serve as a mere indication, as they can vary slightly when printed.



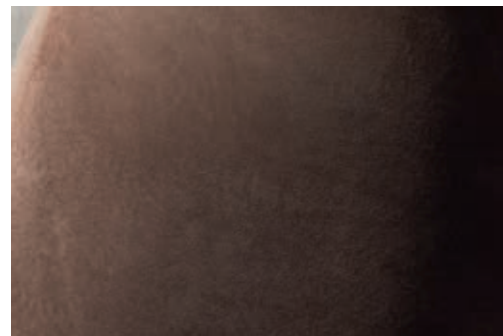

## TAO

Tao è l'elegante collezione di vasi disegnati da Rosaria Copeta per MY YOUR di chiara ispirazione orientale. Come i concetti ritmici e filosofici dello Yin e Yang, i tre vasi Tao si incastrano fra loro perfettamente e compongono un monolite scultoreo molto somigliante al simbolo da cui prendono nome. Presi singolarmente, sono liberamente accostabili fra loro, creando uno stile sinuoso e sempre diverso negli spazi in cui si trovano. Realizzati in Poleasy® sono disponibili nelle finitura gofrata stampata e nella nuova finitura Velvet.

Tao is the elegant collection of vases designed by Rosaria Copeta for MY YOUR with a clear oriental inspiration. Like the rhythmic and philosophical concepts of Yin and Yang, the three Tao vases fit together perfectly and create a sculptural monolith very closed to the symbol from which they take their name. Taken individually, they can be freely combined, creating a sinuous and always different style in the spaces in which they are located. Made of Poleasy<sup>3</sup> they are available in embossed printed finish and in the new Velvet finish.

Struttura Poleasy®

Frame Poleasy®

### Gem S Gem S

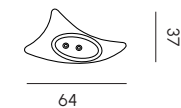
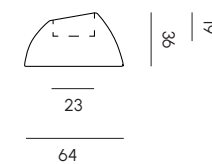

### Gem M Gem M

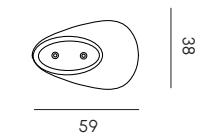
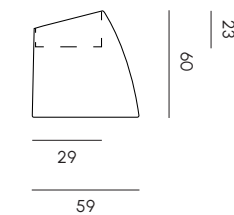

### Gem fioriera, ice-box Gem planter, ice-box

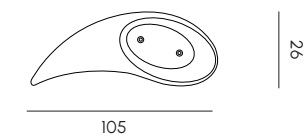
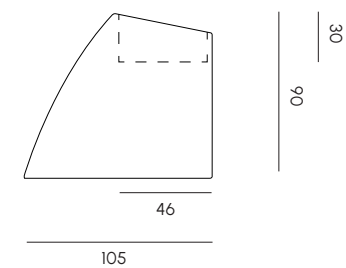



Colori disponibili  
Available colors

Finishing  
GS

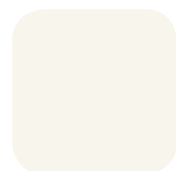

white  
117

Finishing  
VL



velvet beige  
804



velvet green\*  
208



velvet brown  
92



velvet blue\*  
840

\* Per le finiture Velvet green e Velvet Blue la quantità minima ordinabile è di 6 pezzi  
For Velvet Green and Velvet Blue finishes the minimum order quantity is 6 pieces

Le immagini dei materiali e dei colori sono indicative, in quanto possono subire lievi variazioni in stampa.  
The materials and colors images serve as a mere indication, as they can vary slightly when printed.





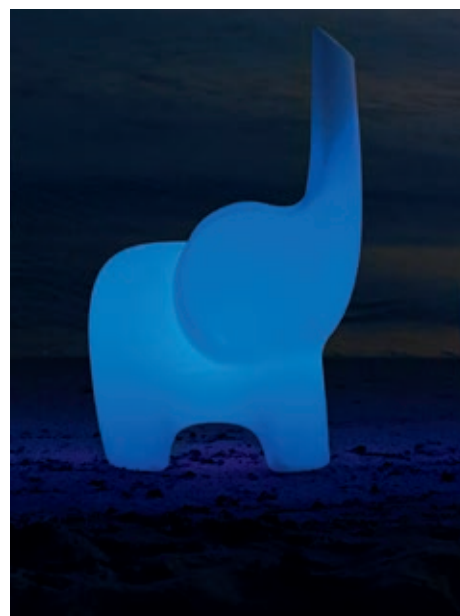

## Tino

Tino è una sedia indoor-outdoor per bambini giocosa e riconoscibile. Nasce dall'idea di Isabella Lovero ed Enrico Bosa che hanno proposto a MY YOUR un oggetto transazionale fra gioco e design. La forma è un archetipo di elefantino la cui proboscide, rivolta verso l'alto, diviene schienale. Tino diviene elemento funzionale, beneaugurante e onirico in grado di comunicare magia a prima vista. Realizzato in Poleasy® e disponibile anche in versione luminosa, è al 100% riciclabile, facile da pulire e testato contro gli agenti atmosferici.

Tino is a kids playful and recognizable indoor-outdoor chair. It was born from Isabella Lovero and Enrico Bosa idea who proposed to MY YOUR a transactional object between game and design object. The shape is an archetype of elephant whose trunk, facing upwards, becomes back. Tino becomes a functional, auspicious and dreamlike element able to communicate magic at first sight. Made of Poleasy® and also available in a light version, it's 100% recyclable, easy to clean and tested against atmospheric agents.

Struttura Poleasy®

Frame Poleasy®

## Tino

Tino

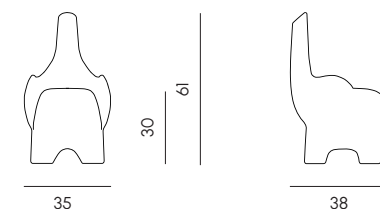

## Colori disponibili\*

Available colors

## Finishing

GS

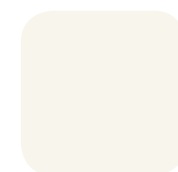

white  
117



orange  
388



lilac  
404



red  
550

\*Minimo d'ordine 2 pezzi dello stesso colore  
Minimum order 2 pieces of the same color

Le immagini dei materiali e dei colori sono indicative, in quanto possono subire lievi variazioni in stampa.  
The materials and colors images serve as a mere indication, as they can vary slightly when printed.



### Tino luminoso Light Tino

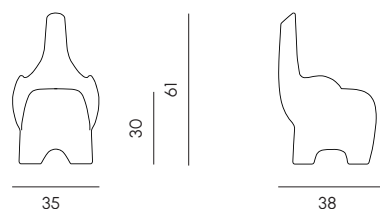

### Colori disponibili Available colors

### Finishing IL

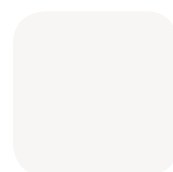

translucent  
110

Struttura	Poleasy®	Frame	Poleasy®
Fonte luminosa	LED RGBW 3,8W 1000mA	Light source	LED RGBW 3,8W 1000mA
Potenza assorbita	Adattatore: AC: 100-240V 50/60Hz DC: 5V	Power Input	Adaptor: AC: 100-240V 50/60Hz DC: 5V
Metodo di ricarica	Induzione elettrica al litio	Recharging method	Lithium electric induction
Tempo di ricarica	4-5 h	Recharging time	4-5 h
Durata di carica	8-10 h	Duration time	8-10 h
Indice di protezione lampada	IP66	Lamp protection index	IP66
Indice di protezione cavo di ricarica	IP20	Recharging cable protection index	IP20
Lunghezza cavo	1,5 m	Recharging cable length	1,5 m
Switch	Telecomando	Switch	Remote control

Le immagini dei materiali e dei colori sono indicative, in quanto possono subire lievi variazioni in stampa.  
The materials and colors images serve as a mere indication, as they can vary slightly when printed.





### Crazy Head

Dall'idea di CrousCalogero per MY YOUR, Crazy Head è sia appendiabiti sia svuotasche sia porta casco. Il suo design ergonomico e distintivo lo trasforma in una divertente alternativa ai prodotti tradizionali con le stesse funzionalità, non solo per bykers. Realizzato in Poleasy®, al 100% riciclabile, può essere collocato in qualsiasi ambiente indoor o outdoor, ed è facilmente fissabile alle pareti, con tutte le viti nascoste per completarne l'estetica.

From the idea of CrousCalogero for MY YOUR, Crazy Head is both clothes hanger, both pocket emptier and helmet holder. Its ergonomic and distinctive design turns it into a fun alternative to traditional products with the same functionality, not just for bykers. Made of 100% recyclable Poleasy®, it can be placed in any indoor or outdoor space, and it's easily fixed to the walls, with all the hidden screws to complete its aesthetics.

Struttura Poleasy®

Frame Poleasy®

### Crazy Head

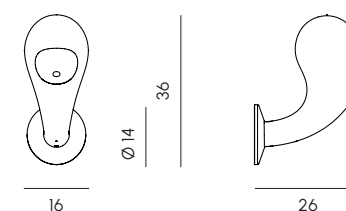

### Colori disponibili\*

Available colors

### Finishing

GS

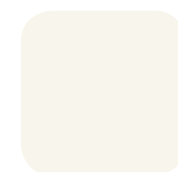

white  
117

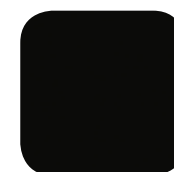

black  
210



gray  
87



lilac  
404



red  
550

\*Minimo d'ordine 2 pezzi dello stesso colore  
Minimum order 2 pieces of the same color

Le immagini dei materiali e dei colori sono indicative, in quanto possono subire lievi variazioni in stampa.  
The materials and colors images serve as a mere indication, as they can vary slightly when printed.



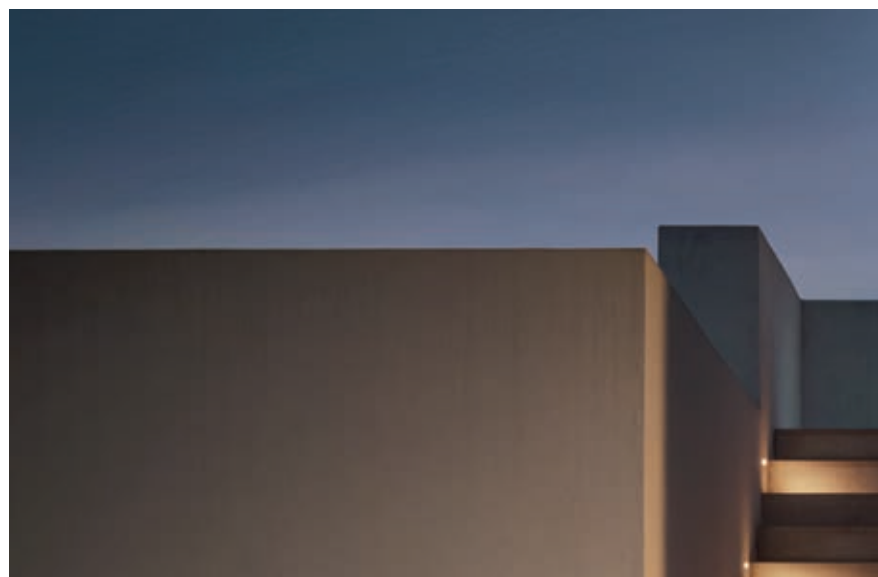

Lampade da terra  
Standing lamps

486 JOY

490 HOLLYWOOD

494 PENELOPE

498, 506 PANDORA LIGHTS

508 AGATA

512 AGATA WOOD

516 AMPOULE

522 TULIP

526 BABYLOVE

Sospensioni  
Pendant lamps

504 PANDORA LIGHTS

530 BABYLOVE

534 NEFOS

Lampade galleggianti  
Floating lamps

498, 502 PANDORA LIGHTS

532 BABYLOVE

Lampade da tavolo  
Table lamps

519 AMPOULE

538 LIGHT TALES



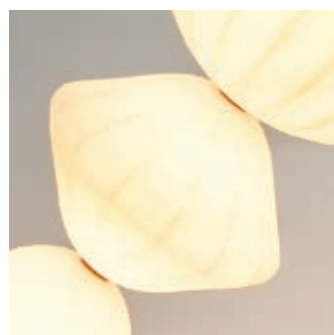

**Joy lampada da terra con base in marmo**  
Joy standing lamp with marble base

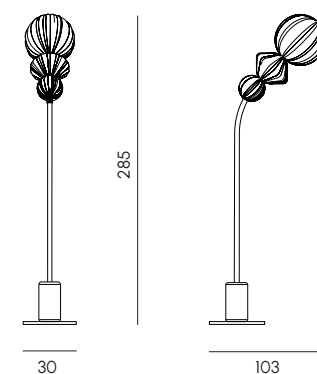

**Joy lampada da terra con base in metallo**  
Joy standing lamp with metal base

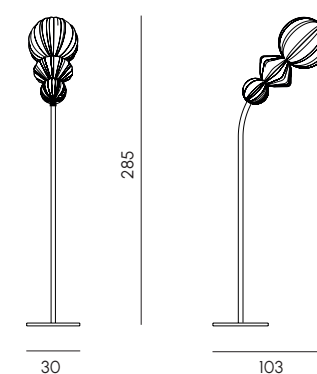

**Joy lampione senza base**  
Joy pathway lamp post without base

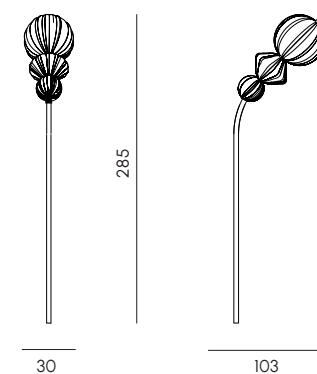

## Joy

JOY è la lampada da terra disegnata da Lanzavecchia-Wai per MY YOUR, che si ispira si ispira dichiaratamente all'atto di infilare gemme preziose in una collana. Il macro formato della lampada viene esaltato dalla luce del paralume in Poleasy®, e dalla finitura rame dello stelo. Disponibile con le basi sia in marmo Filetto Rosso di Trani sia in metallo sia in versione senza base, resiste agli agenti atmosferici e ai raggi UV.

JOY is the floor lamp designed by Lanzavecchia-Wai for MY YOUR, which is inspired by the act of inserting precious gems in a necklace. The lamp macro format is enhanced by the lampshade light in Poleasy®, and by the copper finish stem. Available with Trani Filetto Rosso marble base, in metal base and in without base version, it resists to atmospheric agents and UV rays.



Diffusore	Poleasy®	Lampshade	Poleasy®
Struttura	Metallo con fondo protettivo a cataforesi verniciato a polveri	Frame	Powder-coated metal with cataphoresis protection fund
Basamento (dove previsto)	Marmo Filetto Rosso di Trani	Base (where applicable)	Trani Filetto Rosso marble
Fonte luminosa	230V 50/60Hz 24V per max 75W strips LED 3000K 5000 lm	Light source	230V 50/60Hz 24V for max 75W strips LED 3000K 5000 lm
Alimentazione	110-240V 24V	Power supply	110-240V 24V
Indice di protezione cavo	IP44	Cable IP	IP44
Lunghezza cavo	2,5 m con spina	Cable Length	2,5 m with plug
Switch	Spina	Switch	Plug

#### Colori del diffusore

Lampshade color

#### Finishing

IL

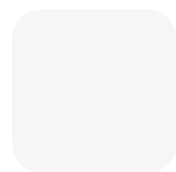

translucent  
110

Le immagini dei materiali e dei colori sono indicative, in quanto possono subire lievi variazioni in stampa.  
The materials and colors images serve as a mere indication, as they can vary slightly when printed.





### Hollywood lampada da terra Hollywood standing lamp

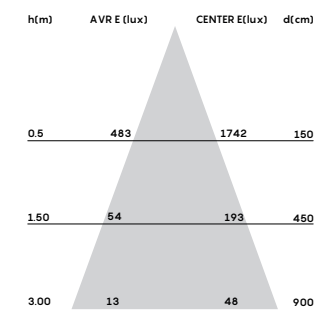
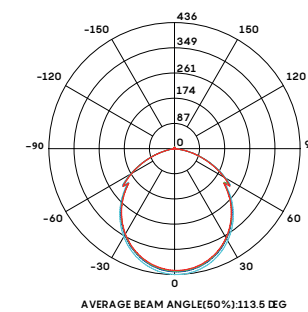
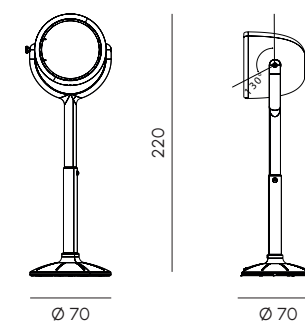
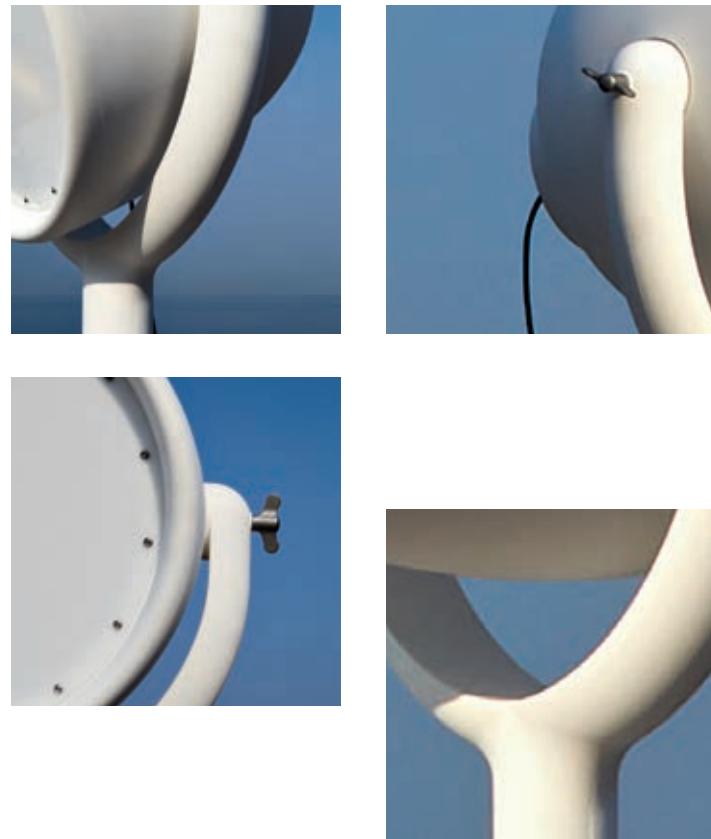

## Hollywood

Hollywood è la lampada da terra in macro formato che caratterizza ogni ambiente grazie al suo suggestivo impatto scenico. Disegnata da Brogliato Traverso per MY YOUR, si ispira ai fari e ai riflettori del cinema anche nei dettagli come la regolazione luminosa e l'orientabilità del corpo illuminante. Hollywood si adatta a contesti sia indoor che outdoor con il suo mood "fashion-industrial". Realizzata in Poleasy®, è di facile pulizia ed è testata per resistere nel tempo agli agenti atmosferici.

Hollywood is the macro format standing lamp that characterizes every space thanks to its striking scenic impact. Designed by Brogliato Traverso for MY YOUR, it's inspired by cinema lights and reflectors also in details such as the light regulation and the lighting body orientability. Hollywood is suitable for both indoor and outdoor setting with its "fashion-industrial" mood. Made of Poleasy®, it's easy to clean and tested to withstand the weather.



Diffusore e struttura	Poleasy®	Lampshade and	Poleasy®
Fonte luminosa	Piastra Led 33W 3000K - 5000 lm CRI80	Light source	33W LED plate 3000K - 5000 lm CRI80
Alimentazione	110-270V 50-60Hz	Power supply	110-270V 50-60Hz
Indice di protezione cavo	IP44	Cable IP	IP44
Lunghezza cavo	3 m con spina	Cable Length	3 m with plug
Switch	Spina	Switch	Plug

#### Colori disponibili

Available colors

##### Finishing GS

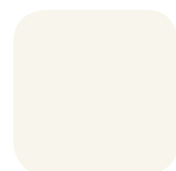

white  
117

##### Finishing OV



pearl gray  
180

##### Finishing OS



copper  
101



brown  
92



dark pearl  
162



rust  
500

Le immagini dei materiali e dei colori sono indicative, in quanto possono subire lievi variazioni in stampa.  
The materials and colors images serve as a mere indication, as they can vary slightly when printed.





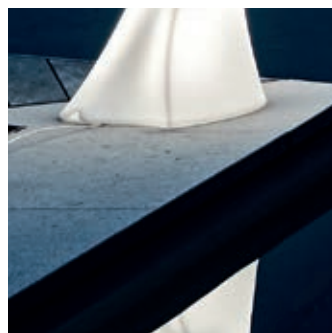
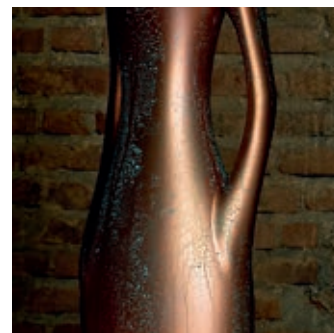
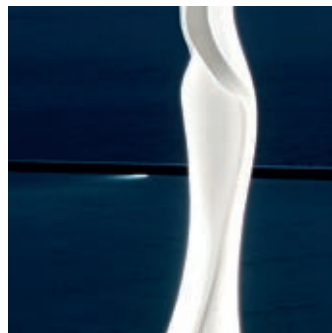

### Penelope lampada da terra Penelope standing lamp

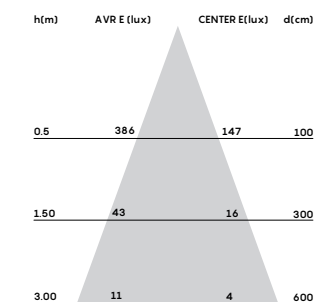
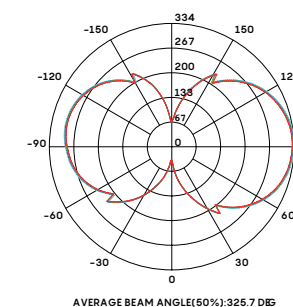
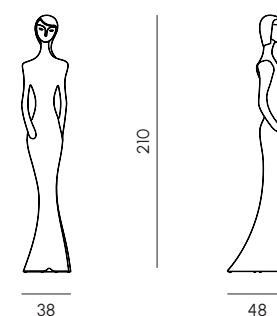

### Penelope basamento\* Penelope base



## Penelope

Ispirata alla scultura greca classica, è una combinazione di design, tecnologia e caratteristiche funzionali avanguardistiche. Con i suoi 210 cm di altezza, Penelope è fatta per stupire: come lampada illumina qualsiasi spazio con la sua bellezza classica, come scultura, in finitura ossidata, decora con eleganza suggestiva ciò che la circonda. Disegnata da More Design per MY YOUR, Penelope è uno dei prodotti icona di MY YOUR sin dalla sua prima produzione.

Inspired by classical Greek sculpture, it is a combination of design, technology and avant-garde functional features. With its 210 cm high, Penelope is made to amaze: as a lamp illuminates any space with its classic beauty. As a sculpture, in oxidized finishing, it decorates with evocative elegance what surrounds it. Designed by More Design for MY YOUR, Penelope has been one of MY YOUR's iconic products since its first production.

\*Le staffe di ancoraggio di Penelope sono incluse nella versione outdoor  
Penelope's anchor brackets are included in outdoor version



Diffusore	Poleasy®	Lampshade	Poleasy®
Fonte luminosa	Strip LED bianco 6200 - 5000 lm CRIBO (bianco)	Light source	White LED stripes 6200 - 5000 lm CRIBO (bianco)
Alimentazione	AC: 100-240V 50/60Hz DC: 12V 5.0A	Power supply	AC: 100-240V 50/60Hz DC: 12V 5.0A
Indice di protezione cavo	IP44	Cable IP	IP44
Lunghezza cavo	2 m con spina	Cable Length	2 m with plu
Switch	Spina	Switch	Plug

#### Colori disponibili Available colors

Finishing  
IL

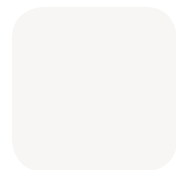

translucent  
110

Finishing  
OS

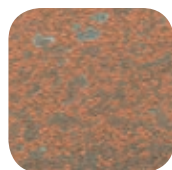

copper  
101

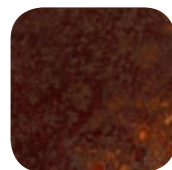

rust  
500

Le immagini dei materiali e dei colori sono indicative, in quanto possono subire lievi variazioni in stampa.  
The materials and colors images serve as a mere indication, as they can vary slightly when printed.





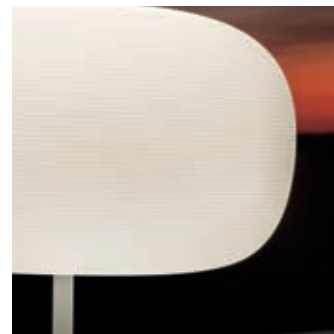
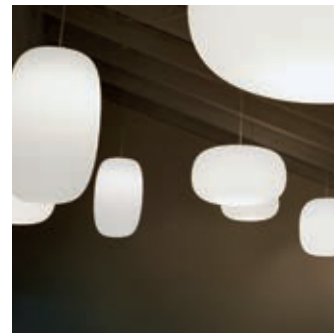
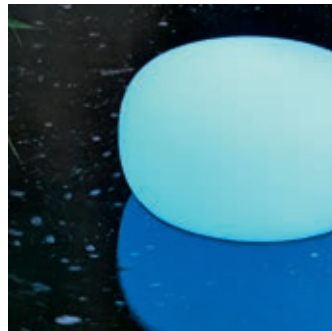

### Lampada da terra e galleggiante S\*

Floor and floating S lamp

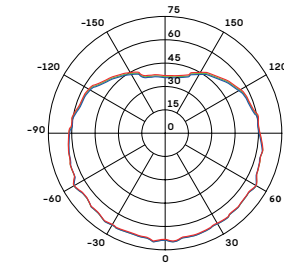
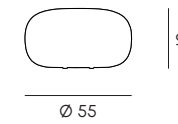

### Lampada da terra M

Floor M lamp

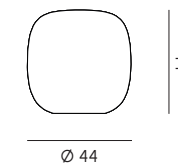

### Lampada da terra L

Floor L lamp

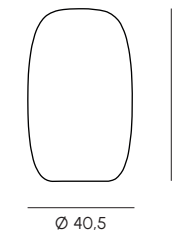

## Pandora Lights

La collezione Pandora si compone di lampade da terra, sospensioni e galleggianti. Le piantane a stelo centrale differiscono per paralume che ha lo stesso design delle sedute S, M e L mentre il modello XL si evolve in una forma ovoidale allungata. Le lampade da terra senza stelo si arricchiscono del tavolino luminoso anche galleggiante. Disegnate da Brogliato Traverso per MY YOUR, sono arricchite dal pattern distintivo di tutta la collezione. Realizzate in Poleasy®, disponibili in luce bianca LED e, dove consentito, in luce RGBW a batteria, le lampade Pandora decorano elegantemente lo spazio in cui si trovano.

The Pandora collection consists of floor, suspensions and floating lamps. The central stem stands differ for lampshade that has the same design as the S, M and L seats while the XL model evolves into an elongated ovoid shape. The floor lamps without stem are enriched with the luminous coffee table also in floating version. Designed by Brogliato Traverso for MY YOUR, they are enriched by the entire collection distinctive pattern. Made of Poleasy®, available in white LED light and, where allowed, in battery-powered RGBW light, Pandora lamps elegantly decorate the space in which they are placed.

### Tavolino luminoso

Light Coffee table

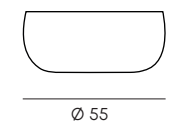

\*Pandora S si utilizza ambivalentemente sia come lampada da terra sia come lampada galleggiante  
Pandora S use is both as floor lamp and as floating lamp



Diffusore*	Poleasy®	Lampshade*	Poleasy®
Fonte luminosa	N°1 lampadina di tipo E27 LED max 20W-230V 50/60Hz (non fornite)	Light source	N°1 E27 LED bulb max 20W-230V 50/60Hz (not included)
Alimentazione	110-240V - 50/60 Hz	Power supply	110-240V - 50/60 Hz
Indice di protezione cavo	IP44	Cable IP	IP44
Lunghezza cavo	2 m con spina	Cable Length	2 m with plug
Switch	Spina	Switch	Plug

\* Lampade da terra Pandora E27  
Pandora E27 floor lamps

#### Colori disponibili Available colors

#### Finishing IL

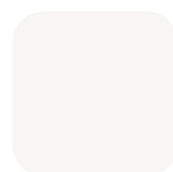

translucent  
110

Le immagini dei materiali e dei colori sono indicative, in quanto possono subire lievi variazioni in stampa.  
The materials and colors images serve as a mere indication, as they can vary slightly when printed.

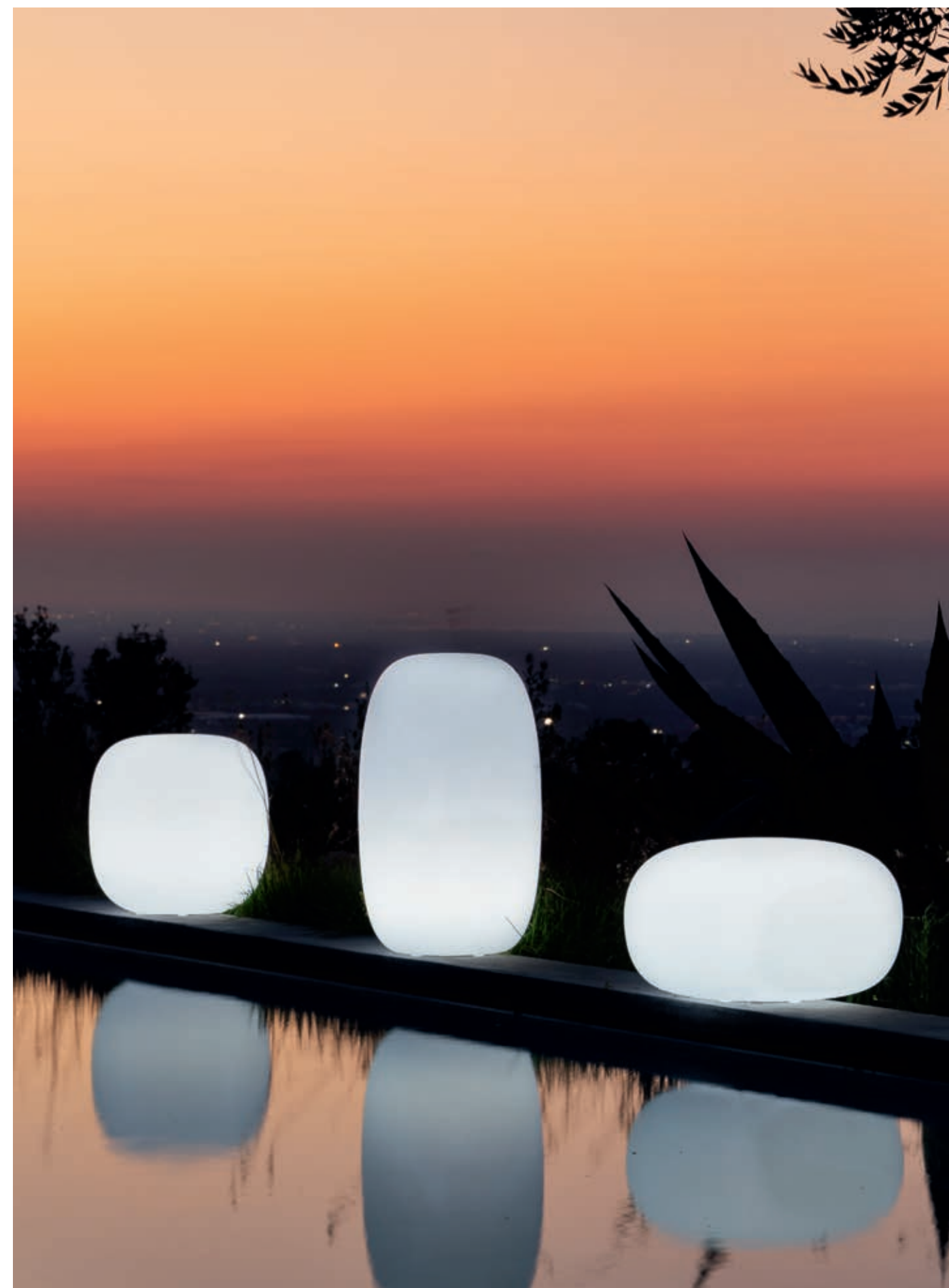



Diffusore*	Poleasy®	Lampshade*	Poleasy®
Fonte luminosa	LED RGBW 3.8W 2000mA	Light source	LED RGBW 3.8W 2000mA
Potenza assorbita	Adattatore: AC: 100-240V 50/60Hz DC: 7.5V	Power Input	Adaptor: AC: 100-240V 50/60Hz DC: 7.5V
Metodo di ricarica	Induzione elettrica al litio	Recharging method	Lithium electrical induction
Tempo di ricarica	4-5 h	Recharging time	4-5 h
Durata di carica	8-10 h	Duration time	8-10 h
Indice di protezione lampada	IP66	Lamp protection index	IP66
Indice di protezione cavo di ricarica	IP20	Recharging cable protection index	IP20
Lunghezza cavo	1,5 m	Recharging cable length	1,5 m
Switch	Telecomando	Switch	Remote control

\* Lampade da terra Pandora con ricarica a induzione  
Pandora floor lamps with induction recharging





### Lampada sospensione S

Pendant S lamp

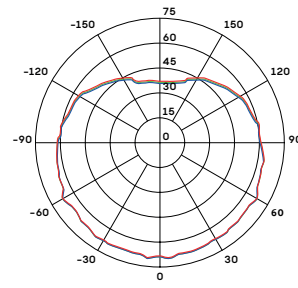
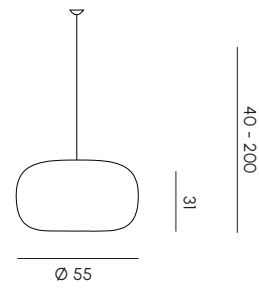

### Lampada sospensione M

Pendant M lamp

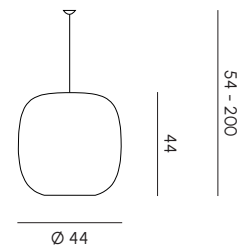

### Lampada sospensione L

Pendant L lamp

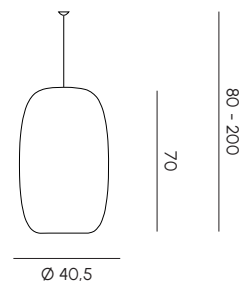

### Rosone

Canopy box



outdoor use

Diffusore	Poleasy®	Lampshade	Poleasy®
Fonte luminosa	N°1 lampadina di tipo E27 LED max 20W-230V 50/60Hz (non fornite)	Light source	N°1 E27 LED bulb max 20W-230V 50/60Hz (not included)
Alimentazione	110-240V - 50/60 Hz	Power supply	110-240V - 50/60 Hz
Indice di protezione cavo	IP66	Cable IP	IP66
Lunghezza cavo	2 m	Cable Length	2 m
Switch	Rosone	Switch	Canopy box

### Colori del diffusore

Lampshade color

### Finishing

IL

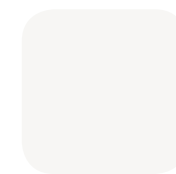

translucent  
110

Le immagini dei materiali e dei colori sono indicative, in quanto possono subire lievi variazioni in stampa.  
The materials and colors images serve as a mere indication, as they can vary slightly when printed.



### Lampada piantana S Standing S lamp

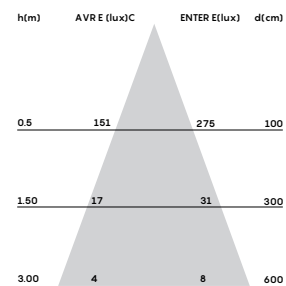
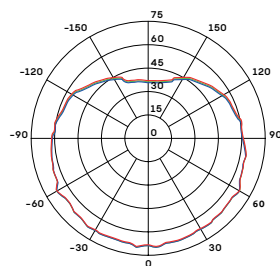
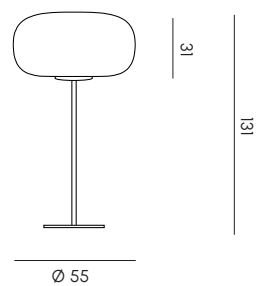

### Lampada piantana M Standing M lamp

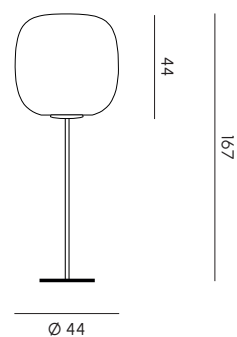

### Lampada piantana L Standing L lamp

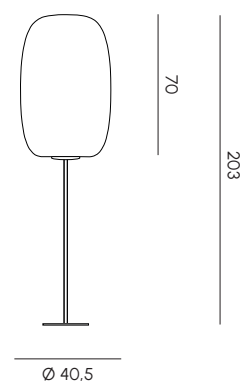

### Lampada piantana M Standing M lamp

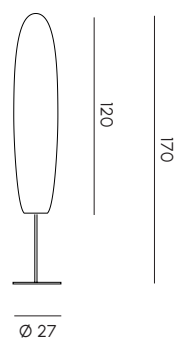

Diffusore	Poleasy®
Struttura e basamento	Alluminio verniciato a polveri epossidiche
Fonte luminosa	N°1 lampadina di tipo E27 LED max 20W-230V 50/60Hz (non fornite)
Alimentazione	110-240V - 50/60 Hz
Indice di protezione cavo	IP44
Lunghezza cavo	2 m con spina
Switch	Spina

Lampshade	Poleasy®
Frame and base	Epoxy powder coated aluminium
Light source	N°1 E27 LED bulb max 20W-230V 50/60Hz (not included)
Power supply	110-240V - 50/60 Hz
Cable IP	IP44
Cable Length	2 m with plug
Switch	Plug

### Colori del diffusore Lampshade color

### Finishing IL

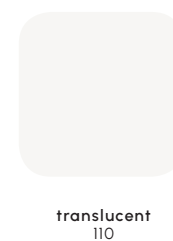

Le immagini dei materiali e dei colori sono indicative, in quanto possono subire lievi variazioni in stampa.  
The materials and colors images serve as a mere indication, as they can vary slightly when printed.



### Lampada da terra Standing lamp

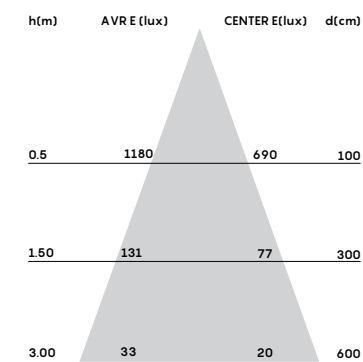
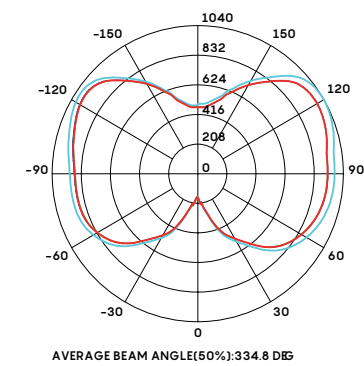
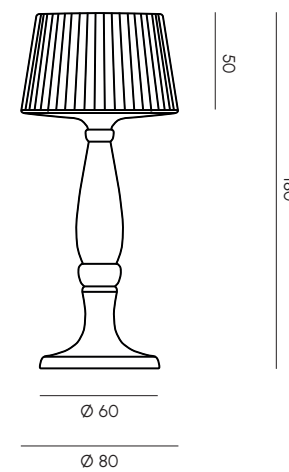
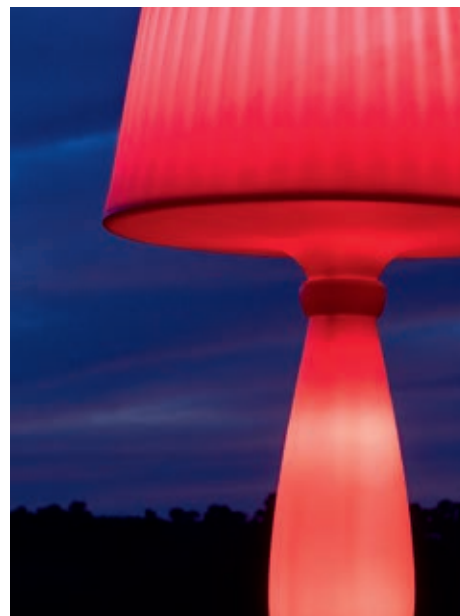
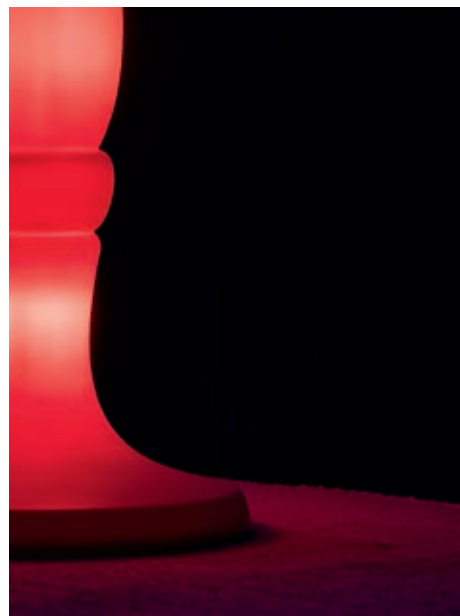

### Agata

Agata è la lampada da terra a stelo centrale in grande formato, disegnata da More Design per MY YOUR, che si ispira dichiaratamente al design classico. Realizzata in Poleasy® si adatta perfettamente a qualsiasi ambiente outdoor, conferendo uno stile eclettico e originale con la sua eleganza stilistica. Riciclabile al 100%, si pulisce facilmente e resiste nel tempo agli agenti atmosferici e ai raggi UV.

Agata is the macro format floor lamp with a central stem, designed by More Design for MY YOUR, which is openly inspired by classic design. Made of Poleasy®, it adapts perfectly to any outdoor space, giving an eclectic and original style with its stylistic elegance. 100% recyclable, it's easy to clean and resists to weathering and UV rays.



Diffusore	Poleasy®	Lampshade	Poleasy®
Fonte luminosa	N°5 lampadina di tipo E27 LED max 20W-230V 50/60Hz in base alla misura (non fornite)	Light source	N°5 E27 LED bulbs max 20W-230V 50/60Hz depending on the size (not included)
Alimentazione	110-240V - 50/60 Hz	Power supply	110-240V - 50/60 Hz
Indice di protezione cavo	IP44	Cable IP	IP44
Lunghezza cavo	2 m con spina	Cable Length	2 m with plug
Switch	Spina	Switch	Plug

#### Colori disponibili

Available colors

Finishing  
IL

Finishing  
OS

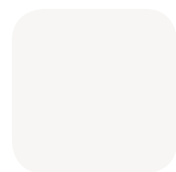

translucent  
110



copper  
101

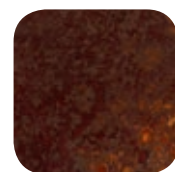

rust  
500

Le immagini dei materiali e dei colori sono indicative, in quanto possono subire lievi variazioni in stampa.  
The materials and colors images serve as a mere indication, as they can vary slightly when printed.





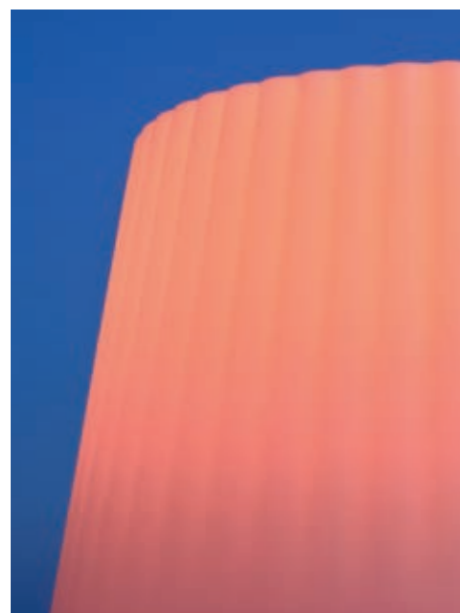

Lampada da terra  
Standing lamp

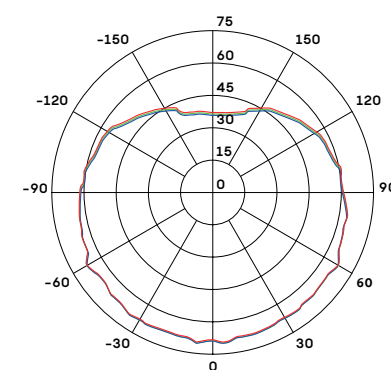
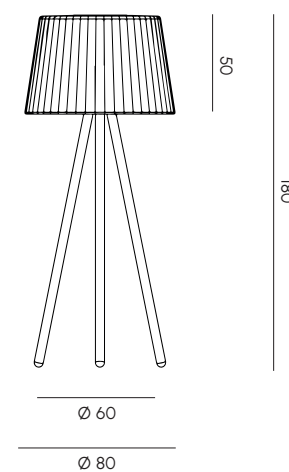

### Agata Wood

Agata Wood è l'evoluzione di Agata in stile Anni Cinquanta, il cui supporto centrale a treppiede, in legno trattato per esterni, è tipico del design di quell'epoca. Realizzata con la moderna tecnologia rotazionale del diffusore in Poleasy®, Agata Wood si adatta ambivalentemente sia per progetti indoor che outdoor. Di facile manutenzione e pulizia, è testata per i raggi UV e per resistere agli agenti atmosferici.

Agata Wood is the Fifties style Agata evolution, whose central tripod support, in treated wood for outdoor use, was typical for that era. Made with the Poleasy® modern rotational technology diffuser, Agata Wood is ambivalently suitable for both indoor and outdoor projects. Easy to maintain and clean, it's tested for UV rays and weather resistance.



Diffusore	Poleasy®	Lampshade	Poleasy®
Basamento	Legno Kotò	Base	Kotò wood
Fonte luminosa	N°1 lampadine di tipo E27 LED max 20W-230V 50/60Hz in base alla misura (non fornite)	Light source	N°1 E27 LED bulb max 20W-230V 50/60Hz depending on the size (not included)
Alimentazione	110-240V - 50/60 Hz	Power supply	110-240V - 50/60 Hz
Indice di protezione cavo	IP44	Cable IP	IP44
Lunghezza cavo	2 m con spina	Cable Length	2 m with plug
Switch	Spina	Switch	Plug

#### Colori del diffusore

Lampshade color

#### Finishing

IL

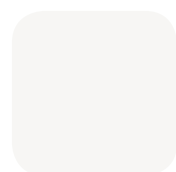

translucent  
110

Le immagini dei materiali e dei colori sono indicative, in quanto possono subire lievi variazioni in stampa.  
The materials and colors images serve as a mere indication, as they can vary slightly when printed.







## Ampoule

Ampoule, disegnata da Brogliato Traverso per MY YOUR, si ispira a una goccia di luce che si ferma a terra. Ampoule è disponibile nella versione da terra oversize per grandi spazi outdoor, e nella versione da tavolo per un effetto decorativo più contenuto. Realizzate in Poleasy®, al 100% riciclabili, entrambi le lampade sono disponibili con sorgente luminosa RGBW o a luce bianca LED e con alimentazione a cavo o a batteria. Ampoule conferisce uno stile senza tempo a ogni contesto in cui si trova.

Ampoule, designed by Brogliato Traverso for MY YOUR, is inspired by a drop of light that stops on the ground. Ampoule is available in the oversize floor version for large outdoor spaces, and in the table version for a more contained decorative effect. Made of 100% recyclable Poleasy®, both lamps are available with RGBW or LED white light source and with cable or battery power. Ampoule gives a timeless style to every context in which it's set.

Diffusore	Poleasy®	Lampshade	Poleasy®
Fonte luminosa	N°1 lampadina di tipo E27 LED max 20W-230V 50/60Hz in base alla misura (non fornite)	Light source	N°1 E27 LED bulb max 20W-230V 50/60Hz depending on the size (not included)
Alimentazione	110-240V - 50/60 Hz	Power supply	110-240V - 50/60 Hz
Indice di protezione cavo	IP44	Cable IP	IP44
Lunghezza cavo	2 m con spina	Cable Length	2 m with plug
Switch	Spina	Switch	Plug

## Lampada da terra XL E27 XL E27 standing lamp

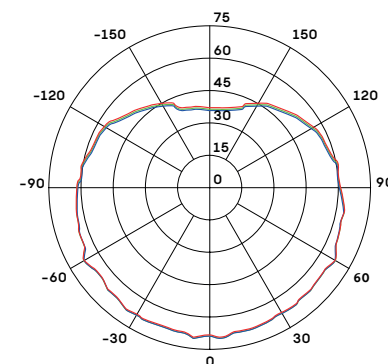
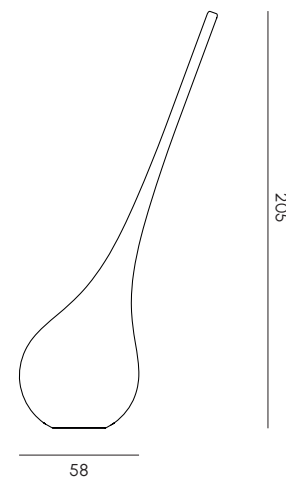



Struttura	Poleasy®	Frame	Poleasy®
Fonte luminosa	LED RGBW 3,8W 2000mA	Light source	LED RGBW 3,8W 2000mA
Potenza assorbita	Adattatore AC: 100-240V - 50/60 Hz DC: 7,5V	Power supply	Adaptor AC: 100-240V - 50/60 Hz DC: 7,5V
Metodo di ricarica	A cavo	Recharging method	Rechargeable cable
Tempo di ricarica	4-5 h	Recharging time	4-5 h
Durata di carica	8-10 h	Duration time	8-10 h
Indice di protezione lampada	IP66	lamp protection index	IP66
Indice di protezione cavo	IP20	Cable protection index	IP20
Lunghezza cavo	1,5 m	Cable Length	1,5 m
Switch	Telecomando	Switch	Remote control

Diffusore	Poleasy®	Lampshade	Poleasy®
Fonte luminosa	N°1 lampadina di tipo G9 LED 1W 220-240V AC 2700K (inclusa)	Light source	N°1 G9 LED 1W bulb 220-240V AC 2700K (included)
Alimentazione	230V - 50/60 Hz	Power supply	230V - 50/60 Hz
Indice di protezione cavo	IP20	Cable IP	IP20
Lunghezza cavo	1,5 m con spina	Cable Length	1,5 m with plug
Switch	Interruttore ON/OFF su cavo trasparente	Switch	ON/OFF switch on transparent cable

### Lampada da terra XL a batteria al Litio

XL Lithium battery standing lamp

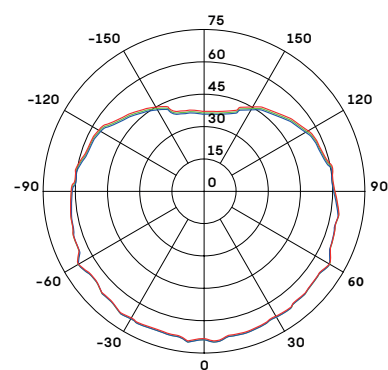
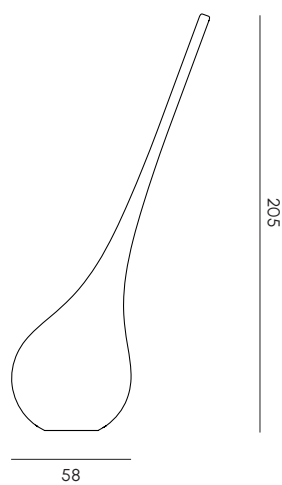

### Lampada da tavolo a cavo

Cable table lamp

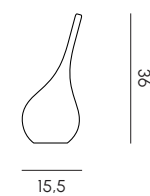



Struttura	Poleasy®	Frame	Poleasy®
Fonte luminosa	LED RGBW 3,8W 2000mA 2700K - 25lm	Light source	LED RGBW 3,8W 2000mA 2700K - 25lm
Potenza assorbita	Adattatore AC: 100-240V - 50/60 Hz DC: 5V	Power supply	Adaptor AC: 100-240V - 50/60 Hz DC: 5V
Metodo di ricarica	Induzione elettrica al Litio	Recharging method	Lithium electric induction
Tempo di ricarica	6 h	Recharging time	6 h
Durata di carica	8-10 h	Duration time	8-10 h
Indice di protezione lampada	IP66	lamp protection index	IP66
Indice di protezione cavo	IP20	Cable protection index	IP20
Lunghezza cavo	1,5 m	Cable Length	1,5 m
Switch	Telecomando	Switch	Remote control

### Colori disponibili per Ampoule XL

Ampoule XL available colors

Finishing  
GS\*

Finishing  
IL

Finishing  
OS

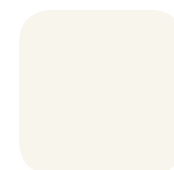

white\*  
117

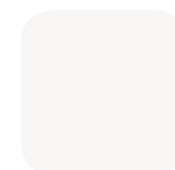

translucent  
110

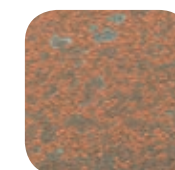

copper  
101



rust  
500

### Lampada da tavolo a batteria al Litio

Lithium battery table lamp

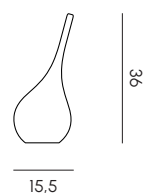

### Colori disponibili per Ampoule lampada da tavolo

Ampoule table lamp available colors

Finishing  
GS\*

Finishing  
IL

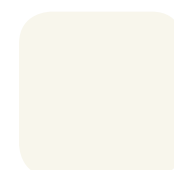

white\*  
117

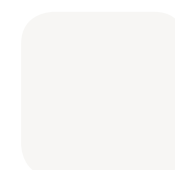

translucent  
110

\* Disponibile solo per Ampoule lampada da tavolo non luminosa  
Available only for Ampoule table lamp without light

Le immagini dei materiali e dei colori sono indicative, in quanto possono subire lievi variazioni in stampa.  
The materials and colors images serve as a mere indication, as they can vary slightly when printed.



### Lampada da terra XL XL standing lamp

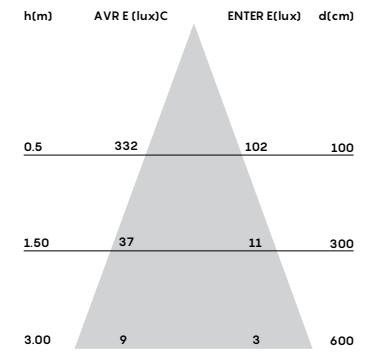
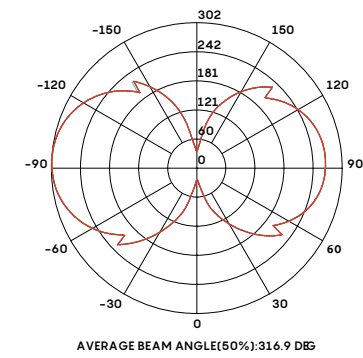
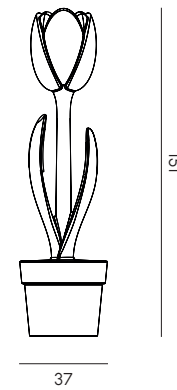

#### Tulip

Tulip, disegnata di More Design per MY YOUR, è una lampada da terra divenuta un'icona riconoscibile per l'azienda stessa. Realizzata in Poleasy® e dal design dichiaratamente pop viene utilizzata sia per spazi indoor che outdoor in versione gofrata stampata e in versione luminosa. Riciclabile al 100%, di facile pulizia e manutenzione, Tulip è un successo senza tempo, tutto in un fiore.

Tulip, designed by More Design for MY YOUR, is a floor lamp that has become a recognizable icon for the company itself. Made of Poleasy®, and with a clear pop design, it's used for both indoor and outdoor spaces in embossed printed or luminous version. Recyclable 100%, easy to clean and to maintain, Tulip is a timeless success, all in one flower.

Diffusore	Poleasy®	Lampshade	Poleasy®
Fonte luminosa	N°1 tubo fluorescente T5 28W L115 cm Philips T528W cod. master: TL5HE28W/840 (not included)	Light source	N°1 fluorescent pipe T5 28W L115 cm Philips T528W master code: TL5HE28W/840 (not included)
Alimentazione	120-277V - 50/60 Hz	Power supply	120-277V - 50/60 Hz
Indice di protezione cavo	IP20	Cable IP	IP20
Lunghezza cavo	4 m con spina	Cable Length	4 m with plug
Switch	Interruttore ON/OFF su cavo trasparente	Switch	ON/OFF switch on transparent cable

#### Colori disponibili

Available colors

#### Finishing

IL



lilac\*  
404

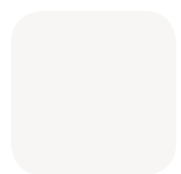

translucent  
110

\*Disponibile solo per Tulip  
Available only for Tulip

Le immagini dei materiali e dei colori sono indicative, in quanto possono subire lievi variazioni in stampa.  
The materials and colors images serve as a mere indication, as they can vary slightly when printed.





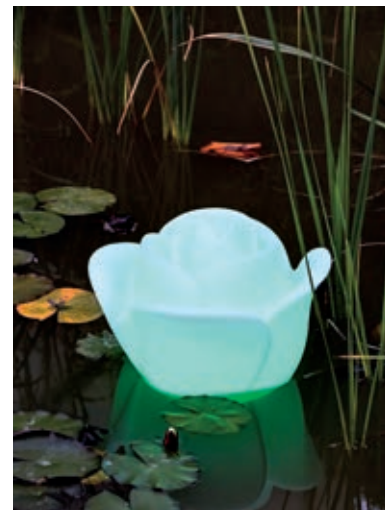

Lampada da terra\*  
Standing lamp

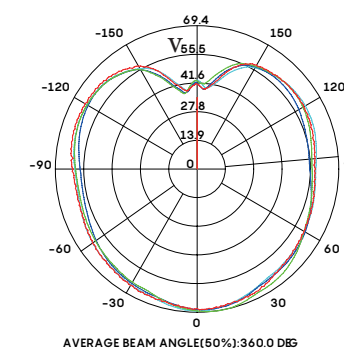
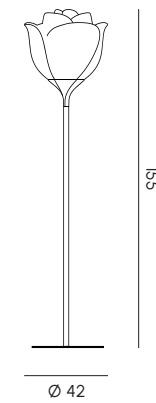

h(m)	AVR E (lux)	CENTER E(lux)	d(cm)
0.5	151	275	100
1.50	17	31	300
3.00	4	8	600

Lampada da terra\*  
Standing lamp



## Babylove

Babylove, disegnata da MY YOUR R&D, è una collezione di lampade costituita da: piantana in due altezze, sospensione per outdoor e lampada galleggiante waterproof con fonte luminosa RGBW e alimentazione a batteria. Babylove è perfetta per locali e hotel alla moda e per scenografie suggestive e poetiche. Realizzata con stelo in alluminio e con paralume in Poleasy®, si pulisce facilmente ed è testata per resistere agli agenti atmosferici e ai raggi UV.

Babylove, designed by MY YOUR R&D, is a lamps collection consisting of standing lamps in two heights, outdoor pendant lamps and waterproof floating lamps with RGBW light source and battery power. Babylove is perfect for trendy clubs and hotels and for evocative and poetic scenographies. Made with aluminum stem and lampshade in Poleasy®, it's easy to clean and tested to withstand the elements and UV rays.

\*Colore struttura e basamento bianco RAL9003  
RAL 9003 white frame and base

Diffusore	Poleasy®	Lampshade	Poleasy®
Struttura e basamento	Metallo con fondo protettivo a cataforesi verniciato a polveri	Frame and base	Powder-coated metal with cataphoresis protection fund
Fonte luminosa	N°1 lampadina di tipo E27 LED max 20W-230V 50/60Hz in base alla misura (non fornite)	Light source	N°1 E27 LED bulb max 20W-230V 50/60Hz depending on the size (not included)
Alimentazione	110-240V - 50/60 Hz	Power supply	110-240V - 50/60 Hz
Indice di protezione cavo	IP44	Cable IP	IP44
Lunghezza cavo	2 m con spina	Cable Length	2 m with plug
Switch	Spina	Switch	Plug

#### Colori del diffusore

Lampshade color

#### Finishing

IL

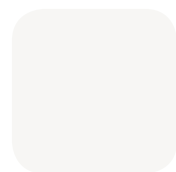

translucent  
110

Le immagini dei materiali e dei colori sono indicative, in quanto possono subire lievi variazioni in stampa.  
The materials and colors images serve as a mere indication, as they can vary slightly when printed.





## Lampada sospensione Pendant lamp

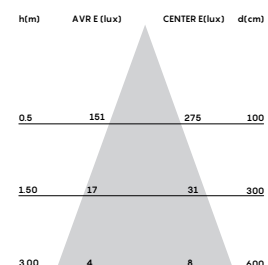
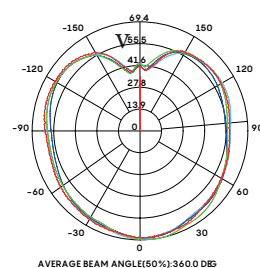
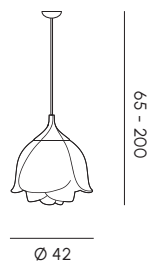

Diffusore	Poleasy®
Fonte luminosa	N°1 lampadina di tipo E27 LED max 20W-230V 50/60Hz in base alla misura (non fornite)
Alimentazione	110-240V - 50/60 Hz
Indice di protezione cavo	IP44
Lunghezza cavo	2 m
Switch	Rosone

Lampshade	Poleasy®
Light source	N°1 E27 LED bulb max 20W-230V 50/60Hz depending on the size (not included)
Power supply	110-240V - 50/60 Hz
Cable IP	IP44
Cable Length	2 m
Switch	Canopy box

## Rosone Canopy box

## Structure PL



outdoor use

## Colori del diffusore Lampshade color

## Finishing IL

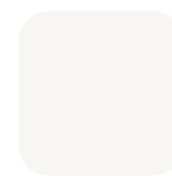

translucent  
110

Le immagini dei materiali e dei colori sono indicative, in quanto possono subire lievi variazioni in stampa.  
The materials and colors images serve as a mere indication, as they can vary slightly when printed.

## Lampada galleggiante waterproof

### Floating waterproof lamp

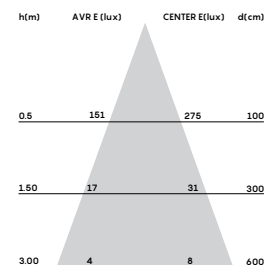
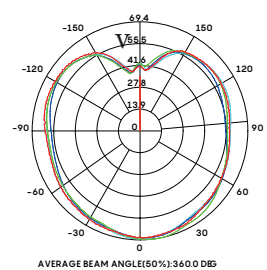
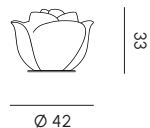

## Colori del diffusore

### Lampshade colors

## Finishing

### IL



translucent  
110

Le immagini dei materiali e dei colori sono indicative, in quanto possono subire lievi variazioni in stampa.  
The materials and colors images serve as a mere indication, as they can vary slightly when printed.

Diffusore	Poleasy®	Lampshade	Poleasy®
Base	Acciaio inox	Base	Stainless steel
Fonte luminosa	LED RGBW 3,8W 2000mA	Light source	LED RGBW 3,8W 2000mA
Potenza assorbita	Adattatore AC: 100-240V - 50/60 Hz DC: 7,5V	Power supply	Adaptor AC: 100-240V - 50/60 Hz DC: 7,5V
Metodo di ricarica	Induzione elettrica al Litio	Recharging method	Lithium electrical induction
Tempo di ricarica	4-5 h	Recharging time	4-5 h
Durata di carica	8-10 h	Duration time	8-10 h
Indice di protezione lampada	IP66	lamp protection index	IP66
Indice di protezione cavo	IP20	Cable protection index	IP20
Lunghezza cavo	1,5 m	Cable Length	1,5 m
Switch	Telecomando	Switch	Remote control



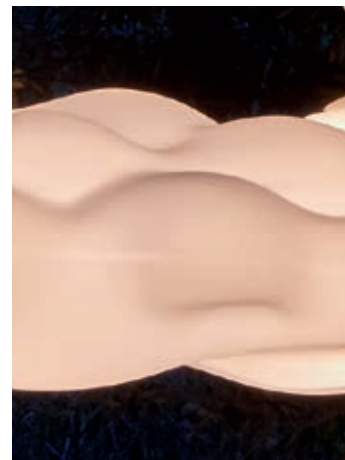
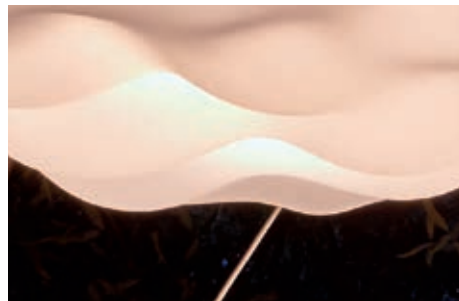

### Lampada sospensione M Pendant lamp M

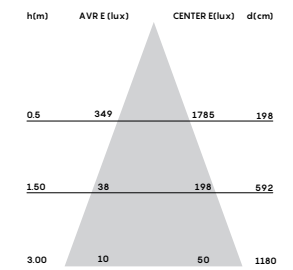
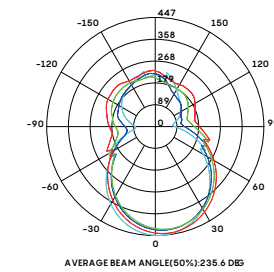
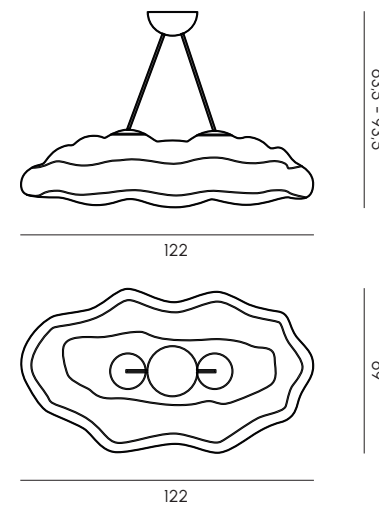

### Lampada sospensione L Pendant lamp L

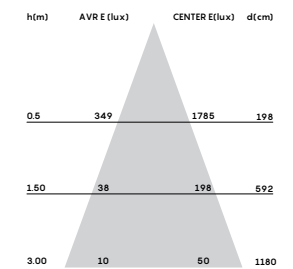
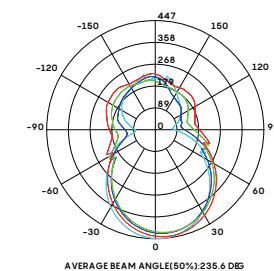
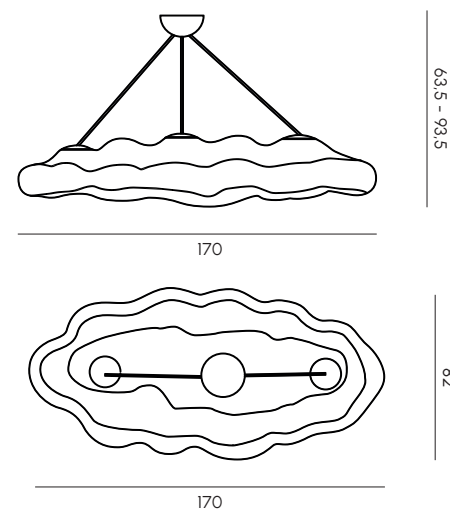

## Nefos

L'Architetto Paolo De Lucchi ha creato per MY YOUR una lampada a sospensione, a luce diffusa, ispirandosi a una nuvola. Nefos illumina tutti gli spazi sia indoor che outdoor che necessitino di un sogno stilistico e di un'atmosfera quasi felliniana. Realizzata in Poleasy®, Nefos è certificata con indice di protezione contro gli agenti atmosferici, e resiste nel tempo e ai raggi UV.

Architect Paolo De Lucchi created a pendant lamp with diffused light for MY YOUR, inspired by a cloud. Nefos illuminates all indoor and outdoor spaces that require a stylistic dream and an almost Fellini atmosphere. Made in Poleasy®, Nefos is certified with protection index against atmospheric agents, and resists over time and UV rays.



Diffusore	Poleasy®	Lampshade	Poleasy®
Fonte luminosa	N°2 o 3 lampadine di tipo E27 LED max 20W-230V 50/60Hz in base alla misura della lampada (non fornite)	Light source	N°2 or 3 E27 LED bulbs max 20W-230V 50/60Hz depending on the lamp size (not included)
Alimentazione	230V - 50/60 Hz	Power supply	230V - 50/60 Hz
Indice di protezione cavo	IP44	Cable IP	IP44
Lunghezza cavo	2 m	Cable Length	2 m
Switch	Rosone	Switch	Canopy box

**Colori del diffusore**  
Lampshade color

**Rosone disponibile**  
Available canopy box

**Finishing**  
IL

**Structure**  
GS

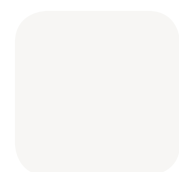

translucent  
110



outdoor use

Le immagini dei materiali e dei colori sono indicative, in quanto possono subire lievi variazioni in stampa.  
The materials and colors images serve as a mere indication, as they can vary slightly when printed.





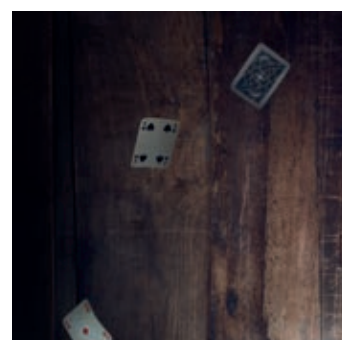

**Mobi lampada da tavolo**  
Mobi table lamp

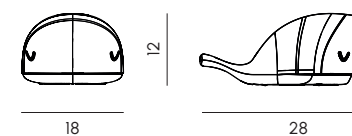

**Mobi XL lampada da terra**  
Mobi XL floor lamp

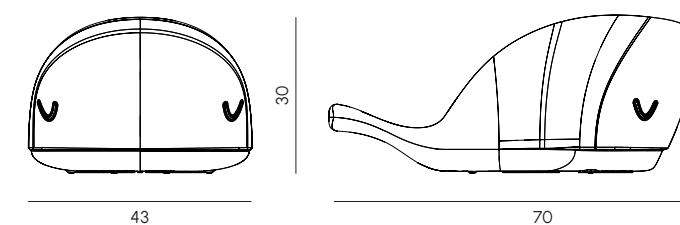

**Cat lampada da tavolo**  
Cat table lamp

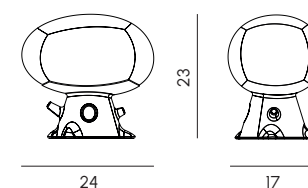

**Tin lampada da tavolo**  
Tin table lamp

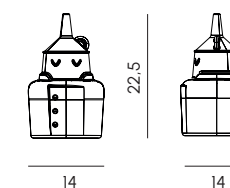

**Rose lampada da tavolo**  
Rose table lamp

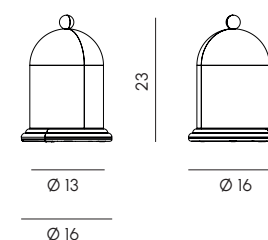

**Tri lampada da tavolo**  
Tri table lamp

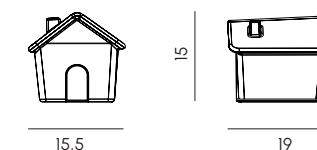

## Light Tales

Light Tales è la collezione di lampade, disegnata da Ale Giorgini e sviluppata da Brogliato Traverso per MY YOUR, che rappresenta le favole più note: "Pinocchio", "La Bella e la Bestia", "Il Mago di Oz", "Alice nel Paese delle Meraviglie" e "I Tre Piccoli Porcellini". Tutte realizzate in Poleasy®, di facile pulizia e manutenzione, quando si accendono fanno esplodere la magia nell'ambiente che le circonda.

Light Tales is the collection of lamps, designed by Ale Giorgini and developed by Brogliato Traverso for MY YOUR, which represents the most famous fairy tales: "Pinocchio", "Beauty and the Beast", "The Wizard of Oz", "Alice in Wonderland", and "The Three Little Pigs". All made of Poleasy®, easy to clean and maintain, when they turn on, they make the magic explode in the space that surrounds them.

Diffusore	Poleasy®	Lampshade	Poleasy®
Fonte luminosa	N°1 lampadina di tipo G9 LED 1W 220-240V AC 6000K (inclusa)	Light source	N°1 G9 LED 1W bulb 220-240V AC 6000K (included)
Alimentazione	230V - 50/60 Hz	Power supply	230V - 50/60 Hz
Indice di protezione cavo	IP20	Cable IP	IP20
Lunghezza cavo	1,8 m con spina	Cable Length	1,8 m with plug
Switch	Interruttore ON/OFF su cavo trasparente	Switch	ON/OFF switch on transparent cable

\* Light Tales S G9 LED  
Light Tales S G9 LED

Struttura*	Poleasy®	Frame*	Poleasy®
Fonte luminosa	LED RGBW 3,8W 1000mA	Light source	LED RGBW 3,8W 1000mA
Potenza assorbita	Adattatore: AC: 100-240V 50/60Hz DC: 5V	Power Input	Adaptor: AC: 100-240V 50/60Hz DC: 5V
Metodo di ricarica	Induzione elettrica al litio	Recharging method	Lithium electric induction
Tempo di ricarica	4-5 h	Recharging time	4-5 h
Durata di carica	8-10 h	Duration time	8-10 h
Indice di protezione lampada	IP66	Lamp protection index	IP66
Indice di protezione cavo di ricarica	IP20	Recharging cable protection index	IP20
Lunghezza cavo	1,5 m	Recharging cable length	1,5 m
Switch	Telecomando	Switch	Remote control

\* Light Tales S con ricarica a induzione  
Light Tales S with induction recharging

## Colori disponibili

Available colors

## Finishing

IL

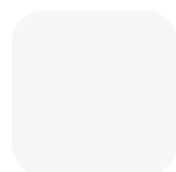

translucent  
110

Le immagini dei materiali e dei colori sono indicative, in quanto possono subire lievi variazioni in stampa.  
The materials and colors images serve as a mere indication, as they can vary slightly when printed.



Diffusore	Poleasy®	Lampshade	Poleasy®
Fonte luminosa	N°1 lampadina di tipo E27 LED max 20W (non fornita)	Light source	N°1 E27 LED bulb max 20W (not included)
Alimentazione	230V - 50/60 Hz	Power supply	230V - 50/60 Hz
Indice di protezione cavo	IP20	Cable IP	IP20
Lunghezza cavo	2 m con spina	Cable Length	2 m with plug
Switch	Spina	Switch	Plug

\* Mobi XL E27  
Mobi XL E27

Struttura*	Poleasy®	Frame*	Poleasy®
Fonte luminosa	LED RGBW 3.8W	Light source	LED RGBW 3.8W
Potenza assorbita	Adattatore: AC: 100-240V 50/60Hz DC: 7.5V	Power Input	Adaptor: AC: 100-240V 50/60Hz DC: 7.5V
Metodo di ricarica	Induzione elettrica al litio	Recharging method	Lithium electric induction
Tempo di ricarica	4-5 h	Recharging time	4-5 h
Durata di carica	8-10 h	Duration time	8-10 h
Indice di protezione lampada	IP66	Lamp protection index	IP66
Indice di protezione cavo di ricarica	IP20	Recharging cable protection index	IP20
Lunghezza cavo	1,5 m	Recharging cable length	1,5 m
Switch	Telecomando	Switch	Remote control

\* Mobi XL con ricarica a induzione  
Mobi XL with induction recharging

## Colori disponibili

Available colors

## Finishing

IL



translucent  
110

Le immagini dei materiali e dei colori sono indicative, in quanto possono subire lievi variazioni in stampa.  
The materials and colors images serve as a mere indication, as they can vary slightly when printed.



Eccellenza nel settore industriale significa innovazione, qualità, manifattura e servizio.

MY YOUR investe da sempre in Ricerca e Sviluppo per apportare migliorie ai propri prodotti e alle problematiche derivate dalle dinamiche produttive. MY YOUR, oggi, è consapevole dell'eccellenza raggiunta tecnologicamente, vantando brevetti come il Poleasy® e investendo in materiali alternativi con una forte attenzione alla sostenibilità. L'esclusività delle finiture proposte, la sicurezza dei materiali, la sfida ingegneristica verso il futuro permeano in MY YOUR la volontà di perfezionare i già magistrali obiettivi raggiunti.

Excellence in the industrial sector means innovation, quality, manufacturing and service.

MY YOUR invests always in R&D to make improvements to its products and to production dynamics problems. Today MY YOUR is aware of the excellence achieved technologically, boasting patents such as the Poleasy® and investing in alternative materials with a strong focus on sustainability.

The exclusivity of the proposed finishes, the materials safety, the engineering challenge towards the future permeate in MY YOUR will to improve the already masterful goals achieved.



### Poleasy® - GS

MYYOUR brevetta un polietilene speciale, il Poleasy®. Messo a punto attraverso un lavoro di ricerca durato molti anni con l'obiettivo di eliminare le microporosità superficiali responsabili della formazione di antiestetiche patine e di possibili fessurazioni nel tempo, Poleasy® ne risolve definitivamente il problema garantendo ai prodotti MYYOUR superfici più compatte e performance eccellenti in fatto di durata, lavabilità e brillantezza dei colori.

MYYOUR patents a special polyethylene named Poleasy®. Developed through many years of research with the aim of eliminating the surface microporosities responsible for the unsightly patinas formations and possible cracking over time, Poleasy® solves the problem definitively by guaranteeing MYYOUR products more compact surfaces and excellent performance in terms of durability, washability and colour brilliance.





### Comparazione fra Polietilene e Poleasy® Polyethylene and Poleasy® comparison

Finishing  
PE



macchia  
stain



pulizia  
cleaning

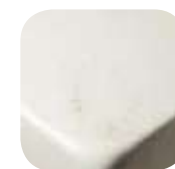

superficie sporca  
dirty surface

Finishing  
Poleasy®

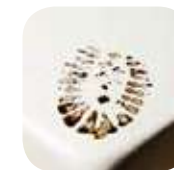

macchia  
stain



pulizia  
cleaning

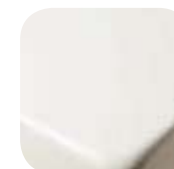

superficie pulita  
clean surface

Poleasy® risolve definitivamente il problema della porosità del polietilene garantendo ai prodotti MYYOUR superfici più compatte e performance uniche in fatto di durata, lavabilità e brillantezza dei colori.

Poleasy® solves the polyethylene porosity problem by ensuring compactness to the surfaces of MYYOUR's products and a better performance in terms of durability, washability and color brightness.



### Velvet - VL

La finitura Velvet di MY YOUR è una lavorazione meccanica superficiale al Poleasy® che crea un effetto tattile vellutato utilizzando una miscela di minerali naturali con trattamenti protettivi testati per outdoor. Avvolgente, morbido alla vista e al tocco Velvet rivoluziona l'approccio al design di settore ed è una risposta sicura e sostenibile alle esigenze progettuali di tendenza.

The Velvet finish by MY YOUR is a mechanical workmanship at the Poleasy®, which creates a velvet tactile effect by using a mixture of natural minerals with protective treatments tested for outdoor use. The Poleasy is the perfect solution for the skin. Enveloping, soft to the eye and to the touch Velvet revolutionizes the approach to the design of the sector and is a safe and sustainable response to the needs of design trends.









### Oxidized - OX

MYYOUR presenta la verniciatura ossidata nei colori rame e ruggine. L'accurata lavorazione, che unisce il Poleasy® e al metallo, prevede l'utilizzo di particelle di ferro come rivestimento, il cui processo di ossidazione viene attivato da prodotti specifici e fermato da un'apposita vernice trasparente specifica per l'utilizzo outdoor. L'unicità del risultato è garantita dall'esecuzione di ogni articolo poiché il procedimento di ossidazione viene operato manualmente.

MYYOUR introduces an oxidised copper and rust coating. The careful processing, which puts together Poleasy® and metal, involves the iron particles use as a coating, whose oxidation process is activated by specific products and stopped by a special specific-for-outdoor-use treatment. The uniqueness of the result is guaranteed by the execution of each article as the oxidation process is done manually.







Dettaglio di finitura Oxidized su Poleasy® e su finitura Illuminated  
Oxidized finishing over Poleasy® and over Illuminated finishes.



### Direct painting - OV

Direct Painting di MY YOUR è una verniciatura speciale, applicata direttamente sulle superfici dei prodotti. Permette di perdere la percezione della materia plastica, rendendola preziosa alla vista e al tatto poiché conserva la sua naturale matericità. Questo trattamento consente nuances che spaziano da cromie matt a effetti metallici molto glamour, aumentando notevolmente le possibilità di personalizzazione dei prodotti.

MY YOUR's Direct Painting is a special coating, applied directly on the products surfaces. It allows to lose the perception of the plastic material, making it precious to the sight and touch as it retains its natural materiality. This treatment allows nuances ranging from matt colors to very glamorous metallic effects, greatly increasing the products customization possibilities.

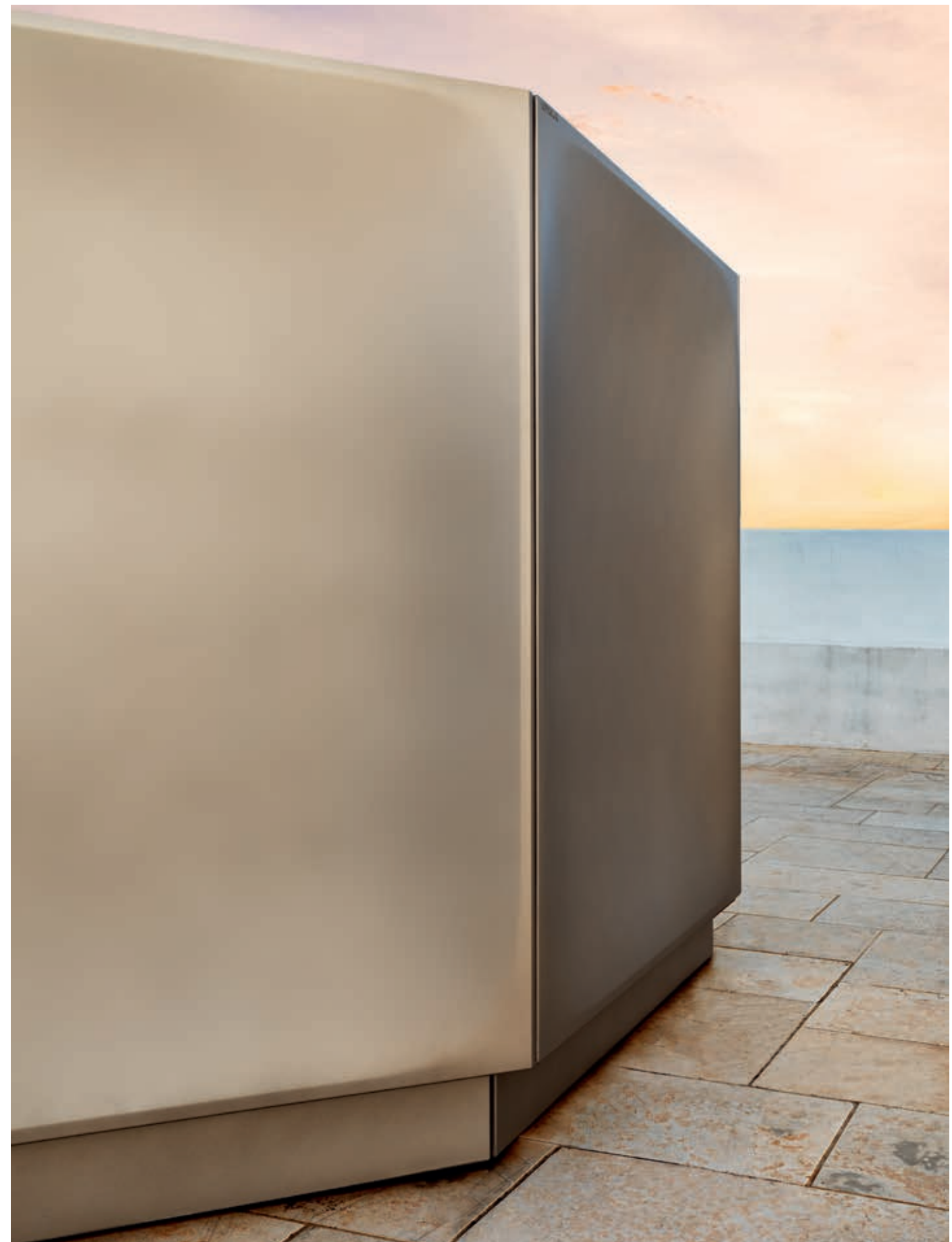







### Dryfeel®

Dryfeel® è una schiuma studiata per gli ambienti esterni e specificatamente in cui il rischio di umidità è maggiore. Dryfeel® risponde a questa esigenza poiché è stata progettata con struttura cellulare efficacemente aperta che consente un completo drenaggio dell'acqua riducendo in modo significativo i tempi di asciugatura e di mantenere le proprie caratteristiche fisiche e chimiche. Trattata con biocidi garantisce l'eliminazione di microorganismi quali batteri, muffe e funghi.

Dryfeel® is a foam designed for outdoor spaces and specifically where the risk of moisture is greater. Dryfeel® answers to this requirement as it has been designed with effectively open-cell structure that allows complete water drainage significantly reducing drying time and maintaining its physical and chemical features. Treated with biocides ensures the elimination of microorganisms such as bacteria, mold and fungi.







Asciugatura più veloce rispetto a un tradizionale tipo di schiuma per imbottitura ( fino a tre volte di più)

Faster drying than a standard padding foam (up to three times more)

Riduzione di tempi di asciugatura fino al 50% di un cuscino finito

Up to 50% drying times reduction o a finished cushion

Maggiore durata anche dopo immersione in acqua di mare e/o piscina

Longer life even after sea and/or swimming-pool immersion

Protezione integrata contro batteri, muffe e funghi

Integrated protection against bacteria, molds and fungi.

Dryfeel® risolve definitivamente il problema del ristagno di acqua e umidità nelle imbottiture e nei cuscini dei prodotti outdoor.

Dryfeel® definitively solves the problem of water and moisture stagnation in the outdoor products padding and cushions.



### Illuminated - IL

La finitura Illuminated di MY YOUR è il Poleasy® nella sua forma più pura ed essenziale che, in assenza di pigmentazione e priva di ogni imperfezione, lascia trasparire la luce. Grazie alla sua impermeabilità e ai corpi cavi ottenuti nel processo rotazionale, Illuminated di MY YOUR consente la possibilità di integrazione con elementi illuminanti che trasformano i pezzi prodotti in lampade decorative e in complementi luminosi.

The MY YOUR's Illuminated finish is made of Poleasy® in its purest and most essential form that, in the absence of pigmentation and without any imperfection, lets shine light. Thanks to its impermeability and the hollow bodies obtained in the rotational process, Illuminated finishing by MY YOUR allows the possibility of integration with lighting elements that transform the pieces into decor lamps and luminous complements.









Creatore di esperienze outdoor, MY YOUR offre materiali di qualità eccellente per ogni spazio all'aperto. Dalla natura selvaggia alle terrazze, MY YOUR unisce tecnologie avanzate a tessuti eleganti in diversi stili. Tutti i materiali MY YOUR sono Made in Italy, resistenti ai raggi UV, a rapida asciugatura e di facile manutenzione.

Oltre alle combinazioni disponibili e selezionate da MY YOUR, è fondamentale la panoramica dei materiali per cogliere tutte le possibilità di personalizzazione e per soddisfare tutte le Vostre esigenze outdoor.

Creator of outdoor experiences, MY YOUR offers the best quality materials for every open-air space. From wild nature to terraces, MY YOUR combines advanced technologies to elegant fabric in different styles. All MY YOUR materials are Made in Italy, UV-resistant, quick-drying, and easy to maintain. In addition to MY YOUR available and selected combinations, you can gain of the materials overview for all the customization possibilities to suit all your outdoor needs.



Basics GS + IL\*  
Basics GS + IL

Finishing  
GS

Finishing  
IL

				
white 117	gray 87	beige 212	beige 804	translucent 110
				
ivory 602	yellow 612	orange 388	red 550	
				
brown 92	marsala 759	lilac 404		
				
light blue 5513	light blue 840	green 662	green 208	
				
light gray 617	anthracite 84	black 210		

\* I colori non sono disponibili per tutti i prodotti e alcuni solo per ordini superiori a 6 pz. Si rimanda, pertanto, alla parte tecnica di ogni prodotto.  
Colors are not available for all products and some of them only for orders over 6 pcs. We therefore refer to the technical part of each product.





**Velvet**  
Velvet

**Finishing**  
VL



velvet beige  
804



velvet green\*  
208



velvet brown  
92



velvet blue\*  
840

\* Disponibile solo per ordini superiori a 6 pezzi  
Available only for more than 6 pieces orders

**Le immagini dei materiali e dei colori sono indicative**  
The materials and colors images serve as a mere indication



**Oxidized (OX) + Direct Painting (OV)**  
 Oxidized (OX) + Direct Painting (OV)

**Finishing**  
OX

**Finishing**  
OV

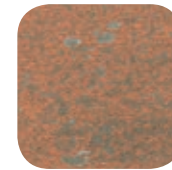

copper  
101



pearl gray  
180



gold\*  
52



rust  
500



dark pearl  
162

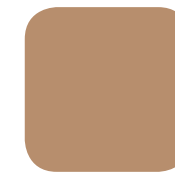

pearly copper\*  
177

\* Disponibile solo per ordini superiori a 6 pezzi  
 Available only for more than 6 pieces orders

**Le immagini dei materiali e dei colori sono indicative**  
 The materials and colors images serve as a mere indication





**Tessuti**  
Fabrics

Samurai Plusline  
Chico  
Nova

Samurai Baseline  
Lily  
Nova sunbed

2054  
Modi

Bali



melange white  
02

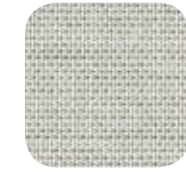

ice  
3966 solid



white  
6



white  
0400



melange gray  
63



gray\*  
3737 solid



sand  
0500



melange light blue  
242



melange green  
7623

\* Disponibile solo per Samurai Baseline  
Available only for Samurai Baseline

Le immagini dei materiali e dei colori sono indicative, i tessuti non sono in scala.  
The materials and colors images serve as a mere indication, fabrics are not in scale.





**Altri materiali**  
Other materials

Flamingo



neutral PL

Bali sun umbrella



polyamide white

Liberty table top

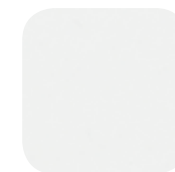

HPL  
white black core  
054

Pandora pendant lamps  
Babylove



outdoor use

Nefos



outdoor use



rope coil



stainless steel



concrete

Le immagini dei materiali e dei colori sono indicative, i tessuti non sono in scala.  
The materials and colors images serve as a mere indication, fabrics are not in scale.



Creative + Photo Direction  
Laura Pozzi Studio

Design + page layout  
Laura Pozzi Studio

Photo  
Adibò

Photolithography  
GM Studio 1

Printed in Italy by  
Imoco spa



**MY YOUR**

via Nino Bixio 20,  
35010 Gazzo, Padova, Italy  
t +39 049 5963419  
f +39 049 5963335  
info@myyour.eu  
www.myyour.eu

Nella stampa su carta la qualità dei colori non può essere riprodotta fedelmente. MY YOUR si riserva la facoltà di apportare modifiche alle proprie collezioni in qualsiasi momento e senza preavviso.

Color shades can not be reproduced accurately on printed paper. MY YOUR is intitled to make modifications at any time and without notice.

